

POSEIDON

PRODUCT RANGE 2019-2

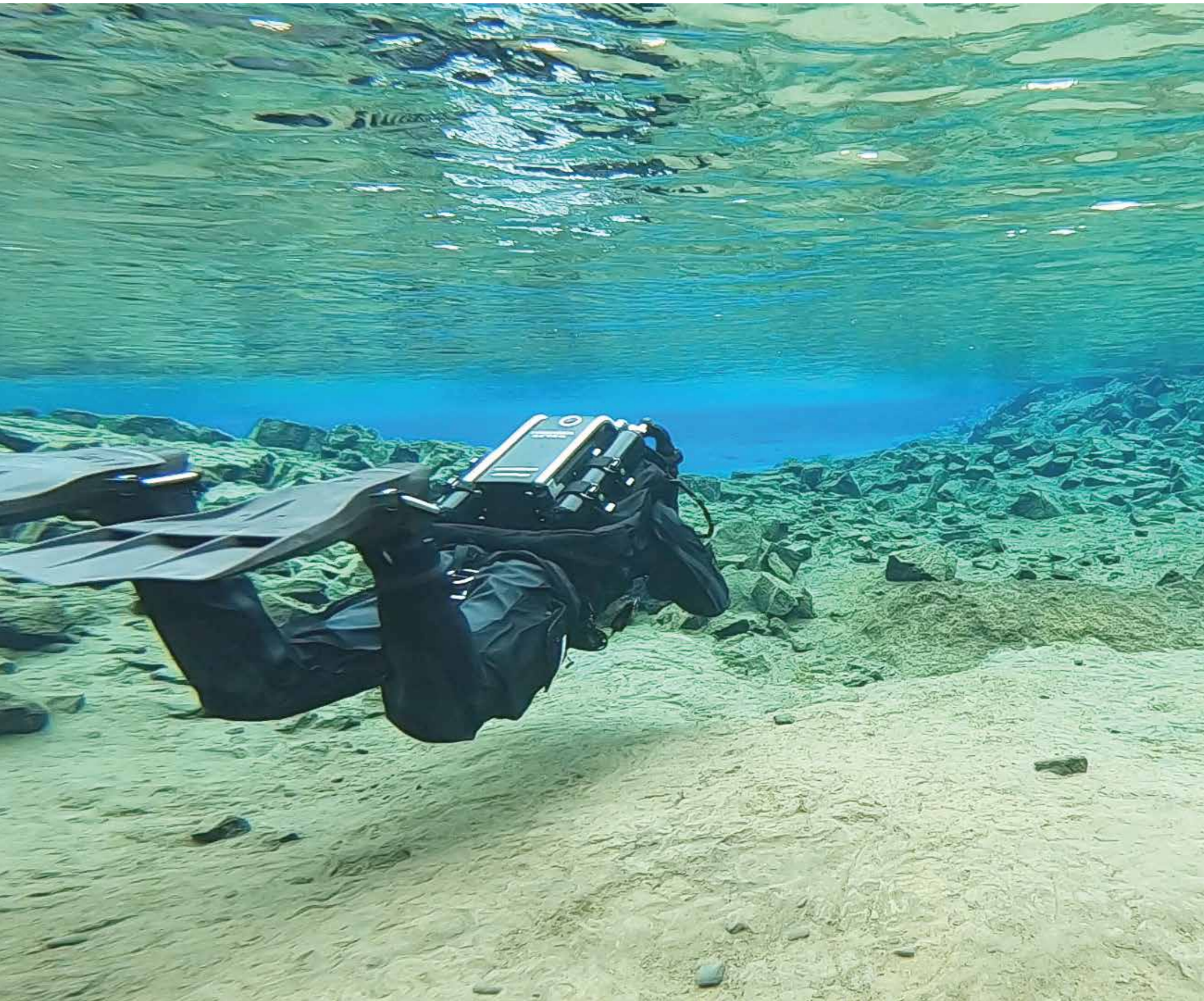



CONTENTS

Rebreather & Accessories	4
Computer & Accessories	12
Cylinders & Valves	16
Regulators & Gauges	18
BCDs & Wings	32
Weight Pockets & Belts	36
Suits & Accessories	38
Masks, Fins & Snorkels	46
Bags, Cases & Other Accessories	50
Apparel	56
Discontinued Products	60
Contacts	64

*This mark * after the article number indicates that is an Order Item, that we do not always have in stock. Please contact sales for current status and delivery information.*

*This mark ** after the article number indicates that it is an Order Item that requires a minimum order quantity (MoQ). Contact sales for price, MoQ and delivery information.*

Further information on products can be found at our homepage www.poseidon.com.

You can place your order on the internet at <http://order.poseidon.com>.

There you will also see your prices and order status as well as your complete order history.

Photo: Santiago Lucciano, A.Mathiesen-Ohman, J.Nilsson, P.Andersson, A.Minnaar et al.

POSEIDON SE7EN

In a world full of compromise, we escape by visiting the one place that doesn't: the ocean. Yet when we get there, we are forced to compromise. Not any more...

The system comprises a breathing loop (mouthpiece, hoses, counter lungs, backpack and scrubber) with associated electronics module (with Smart battery and O2 sensors), and two independent gas cylinders. One contains 100% compressed oxygen which is added to the breathing loop as the diver consumes it. The second cylinder typically contains compressed air "diluent" to compensate for compression in the breathing loop as the diver goes deeper. It's also a backup system, containing enough oxygen for the diver to breathe directly in an emergency.

The SE7EN has big advantages over traditional open circuit equipment:

- > Get closer to marine life
- > Much more time underwater
- > Patented safety technology
- > Proven performance
- > Expandable system
- > Recreational or 100 m technical rebreather
- > Comfortable mouth-piece with patented BOV
- > Dive Management System
- > Plug and play with Dive-by-Wire™
- > Bluetooth connectivity
- > Automatic start-up testing procedure



POSEIDON SE7EN SPORTS EDITION



SE7EN SPORT PACKAGE

- > Poseidon SE7EN without Cover
- > Repackable Scrubber
- > Tank Belt MKVI / SE7EN
- > 11 inch adapter Complete
- > Battery Module - Rec 40 (Green)
- > Rebreather BCD
- > 3L Steel Cylinder Set 300 Bar

Art. no.	Description
6012-013	SE7EN SPORT Package EU version
6012-014	SE7EN SPORT Package US version <i>Cylinders and Cylinder valves are not included in the US version and must be purchased separately.</i>

POSEIDON SE7EN REC EDITION



SE7EN REC PACKAGE

- > Poseidon SE7EN
- > Repackable Scrubber
- > Tank Belt MKVI / SE7EN
- > 11 inch adapter Complete
- > Battery Module - Rec 40 (Green)
- > Rebreather BCD, Recreational Counter Lungs or Back Mounted Counter Lungs
- > 3L Aluminium Cylinder Set 200 Bar or 3L Steel Cylinder Set 300 Bar

Art. no.	Description
6012-015	SE7EN REC Package EU version
6012-016	SE7EN REC Package US version <i>Cylinders and Cylinder valves are not included in the US version and must be purchased separately.</i>

POSEIDON SE7EN TEC EDITION



SE7EN TEC PACKAGE

- > Poseidon SE7EN
- > Repackable Scrubber
- > Tank Belt MKVI / SE7EN
- > 11 inch adapter Complete
- > Battery Module - Deep (Black)
- > Counter Lung Tech Pack or Back-Mounted Counter Lung with Manual Injection Pack
- > Poseidon Harness w. backplate
- > Poseidon Wing WRB
- > RB Handle
- > Cylinder Inversion Kit
- > Poseidon M28 Computer - CCR Ready
- > Connecting Cable M2 1.25m / 4 ft
- > 3L Steel Cylinder Set 300 Bar

Recommended add on:

Third sensor holder + third party computer and cable or another M28, cable and C-pod

Art. no.	Description
6012-017	SE7EN TEC Package EU version
6012-018	SE7EN TEC Package US version <i>Cylinders and Cylinder valves are not included in the US version and must be purchased separately.</i>

POSEIDON SE7EN CUSTOM-BUILD:

Art. no.	Name	Description
6012-010	POSEIDON SE7EN	EU version <i>incl.</i> cover and battery charger.
6012-011	POSEIDON SE7EN	US version <i>incl.</i> cover and battery charger

For EU orders, the Poseidon SE7EN must ship with cylinders from the factory. Cylinders are not included within either the EU or US article numbers and cylinder type must be specified at the time of ordering for EU purchases.

POPULAR ACCESSORIES:

Art. no.	Name	Description
0600-200	POSEIDON M28 Dive Computer	It boasts maps, graphics, GPS, Dive-By-Wire™, and a host of features that deliver class-leading functionality
0005-100	BCD QMR	Designed for easy assembly. The ideal solution for quick BCD attachment
0000-468	11 Inch Adapter	The value choice for attaching your BCD
0100-006	Jetstream Mk3 Octopus	The recommended Octopus for the POSEIDON SE7EN
0650-032	Wing Man, Side Sling Case	Bring your bailout tank with you without bungees and straps
0100-005	Jetstream Mk3 (Black)	Perfect regulator for your bailout kit



COUNTER LUNGS

Art. no.	Description	MATERIAL:	TECHNICAL FEATURE:
6011-049	Standard Counter Lungs For the recreational rebreather diver. 6.2 liter volume.	Ballistic Nylon	6.2 or 8.2 liter volume.
6011-050	Large Counter Lungs For the larger or technical rebreather diver. 8.2 liter volume.		



TECHNICAL COUNTER LUNGS PACK

Art. no.	Description	MATERIAL:	TECHNICAL FEATURE:
6011-035	Technical Counter Lungs Pack <i>incl.</i> Manual injection Pack. For the technical rebreather diver. 8.2 liter volume.	Ballistic Nylon	8.2 liter volume. Manual addition of oxygen and diluent gases.



Art. no.	Description
6011-005	Battery Module – Rec 40 ●
6011-029*	Battery Module – Trimix 60 ○
6011-036	Battery Module – Deep ●

MATERIAL:
Water sealed battery pack in robust plastic.

TECHNICAL FEATURE:
The battery will upgrade your unit to the specific depth limit. The deeper version will also let you specify the trimix used through the PC config program.

BATTERY UPGRADE

40M REC, 60M TRIMIX AND DEEP

Recreational or Technical Rebreather.

A simple battery change upgrades your SE7EN to enable deeper dives, decompression management and mixed gases. This easy upgrade path makes the SE7EN the perfect machine to accompany on your journey as you gain experience as a rebreather diver.

Your battery is highly personalized. It saves your dive logs and nitrogen loading. It also contains a light and speaker that alert your buddy of any alarms. If you put your battery into somebody else's SE7EN, the more conservative settings will be used for your next dive.

BACK MOUNTED COUNTER LUNGS

For divers preferring the back mounted set-up of their rebreather wing/harness. Made for the Poseidon Rebreather Wing/Harness the Back Mounted Counter Lungs have the same material and specifications as the technical counter lungs. Over-the-Shoulder or Back Mounted Counter lungs is a matter of personal preference.



Art. no.	Description	MATERIAL:
6011-066	Back Mounted Counter Lungs For the technical rebreather diver. 8.2 liter volume.	Ballistic Nylon

BMCL ADAPTORS FOR MANUAL INJECTION

Art. no.	Product Name
6011-068	BMCL Adaptors <i>incl.</i> elastic band Adaptors needed to use Manual injection valves.





**BREATHING LOOP
CC HOSE**

These hoses will make it possible for you to customize the lengths of the hoses to fit you better.

The standard length sold with the POSEIDON SE7EN is 346 mm.

Art. no.	Description
0132-000	CC Hose 346 mm, pair.
0135-000	CC Hose 286 mm, pair.
0135-001	CC Hose 396 mm, pair.



**CYLINDER BRACKET
COMPLETE**

Art. no.	Description
0000-467	Cylinder Bracket Complete



MOUTHPIECE G7

Art. no.	Description
0005-055	Mouthpiece G7



**BLIND PLUG
MOUTHPIECE**

Art. no.	Description
0000-368*	Blind Plug Mouthpiece



LP-HOSE DIL 30 CM

Art. no.	Description
0132-006	LP-Hose DIL 3/8"-3/8"M, 30cm



BATTERY CHARGER

Art. no.	Description
6011-015	Battery Charger



POWER ADAPTER 12V

Art. no.	Description
6010-290	Power Adapter 12V



**PLUG ADAPTERS
4-PLUG KIT**

Art. no.	Description
6010-291	Plug Adapters 4-PLUG KIT



**MIFLEX HOSE
POLYURETHANE**

The Miflex Polyurethane hose delivers diluent air to the POSEIDON SE7EN mouthpiece. This hose is of the highest caliber and is an excellent choice for use with both the POSEIDON SE7EN and Poseidon Xstream and Jetstream regulators.

Art. no.	Description
0130-004	LP Hose Polyurethane 9/16-18, 90cm
0130-032	LP Hose DIL 9/16-18, 20cm
0130-033	LP Hose O2 9/16-18, 20cm
0130-034	LP Hose DIL 9/16-18, 20cm w. 90 angle
0130-035	LP Hose O2 9/16-18, 20cm w. 90 angle
0132-007	LP Hose DIL 3/8M-9/16"F, 38cm
0132-008	LP Hose O2 3/8M-9/16"F, 70cm

**3RD CELL HOLDER
WITH T-COUPLING**



Art. no.	Description
6011-052	3rd Cell holder with T-coupling



3RD CELL HOLDER

Poseidon's Third Cell Holder enables you to add a third cell to your rebreather loop to monitor PPO2 on a back up set of electronics. Poseidon's flexible solution enables you to choose whichever back up computer and O2 sensor cell you prefer to use.

Art. no.	Description
6011-064	3rd Cell holder



**MANUAL
INJECTION PACK**

Art. no.	Description
6011-051	Manual Injection Pack

**MANUAL INJECTION
PACK BMCL**

Art. no.	Description
6011-048	Manual Injection Pack for Back Mounted Counter Lungs 2 hose 110 cm



**3RD CELL
CALIBRATION KIT**

Calibration kit for use with 3rd cell holder. Makes O2 cell calibration easy to perform together with external computers.

Art. no.	Description
6011-055	3rd Cell Calibration Kit



**CYLINDER
INVERSION KIT**



Art. no.	Description
6011-054	Cylinder Inversion Kit



CYLINDER QMR SET

The Cylinder Quick Mount Release (QMR) attaches your cylinders even quicker than before and with a perfect fit every time, just as you want them to be. The QMRs are made out of steel and will snap into place on the side of your scrubber canister house.

Art. no.	Description
0415-002	Cylinder QMR Set



REPACKABLE SCRUBBER CARTRIDGE

The scrubber is tested in accordance with the EN14143:2013 with the Poseidon SE7EN rebreather.

Art. no.	Description
6011-069	Repackable Scrubber Cartridge

SCRUBBER CARTRIDGE FILTER

Art. no.	Description
6011-070	Scrubber Cartridge Filter Pair



POSEIDON SOLID STATE O2 SENSOR

Art. no.	Description
6011-063	Poseidon Solid State O2 Sensor (Currently only sold as part of CPOD packages)



O2 SENSOR (MOLEX)

Art. no.	Description
6010-206	O2 Sensor (Molex)



RB HANDLE

The stainless steel handle is easily mounted in combination with QMR adapter or 11 inch adapter. This will make your rebreather easy to grab and carry.

Art. no.	Description
6011-019	RB Handle

MATERIAL:

Stainless Steel

TECHNICAL FEATURE:

Quick mount/dismount



QMR

The Quick Mount/Release adapter presents the fastest solution to mount and dismount your Poseidon SE7EN to your BCD/Wing.

Art. no.	Description
0005-100	QMR Rebreather BCD

MATERIAL:

Stainless Steel

TECHNICAL FEATURE:

Quick solution for mount/dismount



11 INCH ADAPTER

This adapter enables the tightest fit between your Poseidon SE7EN and your BCD/Wing. This is the choice if you don't dismount your unit from the buoyancy device too often.

Art. no.	Description
0000-468	11 inch Adapter Complete

MATERIAL:

Stainless Steel

TECHNICAL FEATURE:

Low profile

TANK BAND STANDARD

COLORS

Black



Art. no.	Description
0000-116	Tank Band Standard



TANK STRAP & BUCKLE

COLORS

Black



Art. no.	Description
0415-001	Tank Strap & Buckle (Pair L&R)

MATERIAL:

Stainless Steel.



DISPLAY GAUNTLET

COLORS

Black



Art. no.	Description
0605-001	Display Gauntlet S
0605-002	Display Gauntlet L

MATERIAL:

Ballistic Nylon 1680, YKK Waterproof Zipper, Octopus Velcro.



GIGASEPT

Art. no.	Description
0050-003*	Gigasept disinfection liquid



POSEIDON M28 COMPUTER

“The world’s most powerful dive computer”

The Poseidon M28 Dive Computer has set new standards for dive computer performance. It boasts maps, graphics, GPS, Dive-By-Wire™ and a host of features that deliver class-leading functionality that’s incredibly intuitive to use.



POSEIDON M28



The main features of the M28 include:

- > Powerful graphics thanks to a class leading 2.8" TFT LCD Color Display
- > Highly intuitive user interface with two button control
- > Enhanced SE7EN/MKVI functionality with the M28's Rebreather Management System
- > Dive-By-Wire™ enables you to make changes to set-points and gases during dive. Integration is possible with Poseidon Pod Systems, HUD and HP Sensors
- > Dual Deco Algorithm (DCAP and Bühlmann ZHL16C with gradient factors)
- > Real-time GPS Surface Positioning and maps
- > Depth rated to 200M/656 ft

Art. no.	Description
0600-200	Poseidon M28 Computer. Incl. Firmware CCR and Firmware Advanced OC. Carrying case, Dust bag, Charging cable and Bungee cord.
0600-210	Poseidon M28 Computer (0600-200) and CPOD/Solid State Sensor kit (6011-064)

M28 PROTECTIVE COVER



Art. no.	Description
0605-000	M28 Protective Cover, Black.
0605-030	M28 Protective Cover, Red

M28 SCREEN PROTECTION



Art. no.	Description
0002-164	M28 Screen Protection

CPOD INCL. SSO2 AND CABLE



Solid State O2 Sensor features:

- > Absolute oxygen measurement
- > Factory calibrated, no need for user calibration
- > Fast and accurate
- > Low power consumption

Art. no.	Description
6011-064	CPOD, T-Coupling, Poseidon Solid State O2 Sensor and Connecting Cable 1.25m/4ft

POSEIDON M28 CHARGING CABLE



Art. no.	Description
0005-042	M28 Charging Cable

POSEIDON M28 BUNGEE CORD



Art. no.	Description
0000-938	M28 Bungee Cord

O2 SENSOR (MOLEX)



Art. no.	Description
6010-206	O2 Sensor (Molex)

POSEIDON SOLID STATE O2 SENSOR



Art. no.	Description
6011-063	Poseidon Solid State O2 Sensor (Currently only sold as part of CPOD packages)

CONNECTING CABLE M2



Art. no.	Description
0000-690	Connecting cable M2, 1.25 m/4 ft.

BUS BLOCK F2M



Art. no.	Description
6011-061*	BUS Block F2M

BUS BLOCK M2F



Art. no.	Description
6011-062*	BUS Block M2F

T-COUPLING



Art. no.	Description
6011-059	T-Coupling

CPOD



The Poseidon C-POD uses an integrated CAN bus to directly connect to the SE7EN or M28 network to monitor and log the required parameters.

Typical adaptations of the Poseidon C-POD with a M28 includes:

- > Monitor loop PO2 individually or as back up.
- > Deploy the Poseidon mouthpiece and HUD system.
- > Deliver life-saving information on PO2, loop status and calculated decompression.

Art. no.	Description
6011-058	CPOD

CPOD INCL. T-COUPLING



Art. no.	Description
6011-060	CPOD incl. T-Coupling

BLIND PLUG BUS



Art. no.	Description
0605-005	Blind Plug BUS





**CYLINDER ALU
3LTR 200 BAR**

Diameter: 117 mm / 4.61 Inch
 Length: 440 mm / 17.32 Inch
 Weight: 3.60 kg / 7.9 lb (US)
 Test Pressure: 312 Bar / 4,525 PSI
 Thread Specification: 97/23/EC

Art. no.	Description
0400-100	Cylinder Aluminium 3Ltr 200 Bar DIL
0400-101	Cylinder Aluminium 3Ltr 200 Bar O2

MATERIAL:

Aluminium.

TECHNICAL FEATURE:

Working Pressure Diluent: 200 Bar / 2,900 PSI.
 Working Pressure Oxygen: 135 Bar / 2,000 PSI.



**3.0 LTR ALU CYLINDER SET
200 BAR WITH VALVES**

Art. no.	Description
0405-000	3L Aluminium Cylinder Set - EU



**CYLINDER STEEL
3LTR 300 BAR**

Diameter: 100 mm / 3.94 Inch
 Length: 510 mm / 20.08 Inch
 Weight: 4.80 kg / 10.58 lb (US)
 Test Pressure: 490 Bar / 7,107 PSI
 Thread Specification: 97/23/EC

Art. no.	Description
0400-103	Cylinder Steel 3Ltr 300 Bar
0400-119	Cylinder Steel 3Ltr 300 Bar O2

MATERIAL:

Chromium molybdenum steel.



**3.0 LTR STEEL CYLINDER SET
300 BAR WITH VALVES**

Art. no.	Description
0406-003	3L Steel Cylinder Set - EU



CYLINDER VALVE SINGLE

Art. no.	Description
0410-100**	Cylinder Valve M25x2 Single G5/8" 200 Bar



CYLINDER VALVE SINGLE O2

Art. no.	Description
0410-101**	Cylinder Valve M25x2 Single M26x2 150 Bar O2



CYLINDER VALVE SINGLE 90°

Art. no.	Description
0410-155*	Cylinder Valve M25x2 Single G5/8" 200 Bar 90°



CYLINDER VALVE SINGLE O2 90°

Art. no.	Description
0410-156*	Cylinder Valve M25x2 Single M26x2 200 Bar 90° O2



CYLINDER VALVE DOUBLE

Art. no.	Description
0410-120**	Cylinder Valve M25x2 Double G5/8" 200 Bar



INLINE VALVE BLACK

Art. no.	Description
0410-161	Inline Valve 3/4", G5/8" 237 Bar, US with Burst Disk
0410-171	Inline Valve M25x2, G5/8" 232 Bar, EU
0410-173	Inline Valve M25x2, G5/8" 300 Bar, EU



INLINE VALVE GREEN O2

Art. no.	Description
0410-160	Inline Valve 3/4", G5/8" 237 Bar O2, US with Burst Disk
0410-170	Inline Valve M25x2, M26x2 232 Bar O2, EU
0410-172	Inline Valve M25x2, M26x2 300 Bar O2, EU

REGULATORS & GAUGES

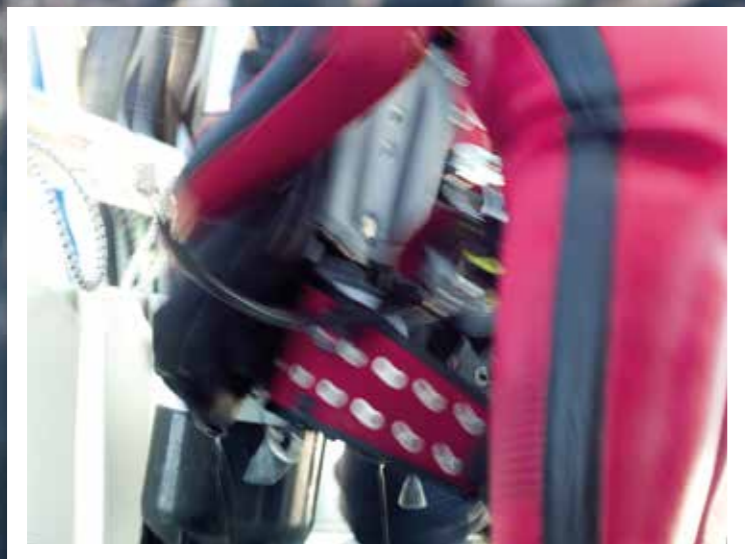
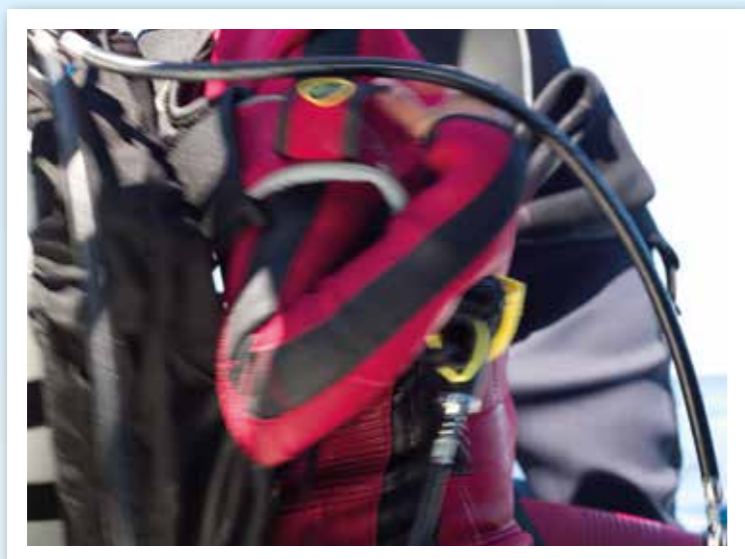

POSEIDON XSTREAM

THE BENCHMARK FOR HIGH PERFORMANCE. WHETHER YOU DIVE WITH AIR, TRIMIX OR OXYGEN, THE XSTREAM OUTPERFORMS ALL OTHER REGULATORS. CERTIFIED TO 200M. AS USED BY THE US NAVY.



KEY PERFORMANCE FEATURES:

- > Side purge prevents current-induced free flow
- > Side vent diverts bubbles from face
- > EAN 40 ready and compatible
- > Works perfectly either way up, or from left or right side
- > Only regulator certified for 200 m / 656 ft
- > No environmental sealing required for cold water

Art. no	Product Name
0100-000	Xstream Deep MK3, for air, nitrox 50% and trimix
0100-001*	Xstream Duration M26 (EU), Green, for oxygen. Excl. LP-hose.
0100-003	Xstream Octopus, Yellow
0100-007	Xstream Duration G5/8" (US), Green, for oxygen. Excl. LP-hose.
0100-010	Xstream Black, for air, nitrox 50% and trimix

SINGLE KIT XSTREAM BLACK

- > 1st Stage Xstream Black Regulator
- > Xstream Octopus Black/Yellow incl. Hose
- > Xstream Black/Black incl. Hose
- > Pressure Gauge Yellow with Hose
- > Neckstrap
- > User guide

Art. no	Product Name
0100-590	Xstream Black w. Octo & Ye. PSG Bar
0100-591	Xstream Black w. Octo & Ye. PSG Psi
0100-578	Xstream Cold Water Double kit, incl. 2 pcs 1st stage, 2 pcs 2nd stage, LT hose 60 & 215 cm

Hardcore, redefined. The preferred performance regulator of the US Navy, US Coastguard, and German Bundeswehr, brings divers the ultimate in performance in all water conditions and at all depths (certified to 200m/656 ft).

SINGLE KIT XSTREAM DEEP

- > 1st Stage Xstream Regulator
- > Xstream Octopus Yellow incl. Hose
- > Xstream Deep MK3 incl. Hose
- > Neckstrap
- > With or without Pressure Gauge Black incl. Hose
- > User guide



Art. no	Product Name
0100-560	Xstream Deep w Octo & Black PSG
0100-580	Xstream Deep w Octopus

MATERIAL:

Durable PCS housing with metal mechanism and rubber parts.

TECHNICAL FEATURES:

- > Trimix, nitrox 50% and air
- > 5 LP and 2 HP-ports
- > Low WOB - Servo assisted
- > Certified to 200 m
- > O2 Certified



COLORS



XSTREAM RANGE

POSEIDON KEEPS INNOVATING

The objective; design the most reliable HP valve in the world. Every engineer knows the benefits of using balls in valve arrangements, since they will never be misplaced and will always find their perfect position. Unfortunately, varying upstream pressures will either push the ball too fiercely into the seat or leave it unsecurely loose, giving unbalanced characteristics.

By inventing the floating seat (which automatically repositions the ball) the increased upstream pressure is balanced equally with increased and counter-acting compression forces from the pressure adjustment spring, maintaining the benefits of having a perfect ball as the sealing element. The Xstream regulator is also self-balancing, which gives the same high performance irrespective of the pressure in the cylinder. When the seat is moved upwards by the high pressure, the design causes the upper pressure spring to compress and thus exactly self-balance the powers of pressure.

Xstream also has a built in anti freeze protection in its construction. TDA (Thermo Dynamic Antifreeze) ensures that the through-flowing water keeps the ice away, entirely without fluids or extra diaphragms.

The Xstream Deep: The Xstream Deep: rated for use down to 200m and for use with mixtures containing helium (He) and a maximum O2 content of 40%. Colour coded Black on both stages to avoid confusion with other gas mixes. All Xstream hoses are oxygen clean and delivered in a sealed bag and they are available in the following lengths: 70, 90, 150, 215 cm (28, 36, 60, 85 inches).

Duration: Colour coded green for oxygen enriched gas on both first and second stage to avoid confusion with other mixes. This regulator fulfills the O₂ requirements for O₂ content up to 99,95% O₂; O₂-engineered O₂-compatible, O₂-clean and O₂-approved. All Xstream hoses are oxygen clean and delivered in a sealed bag and they are available in the following lengths: 70, 90, 150, 215 cm (28, 36, 60, 85 inches).

O₄ REQUIREMENTS FOR SAFE OXYGEN USAGE

Xstream fulfils the O₄ requirements for safe oxygen (O₂) usage. These are;

- O₁ – oxygen engineered
- O₂ – oxygen compatible materials
- O₃ – cleaned for oxygen use
- O₄ – oxygen approved

O₁, oxygen engineered – constructing a regulator for oxygen use requires special engineering skills. It is not as simple as taking any regulator and changing the materials to be so-called "oxygen compatible". Care must be taken, for example, to minimise the use of polymeric materials, avoid intersecting holes and sharp turns, minimise flow velocity, evaluate heat transfer and optimise it, ensure the product does not produce contaminants during assembly, make cleaning and inspection efficient, etc.

O₂, oxygen compatible materials – the term "oxygen compatible" must not be taken too literally; it is meaningless to refer to a material as being "perfectly oxygen compatible".

It is more a matter of choosing materials according to a set of factors which will result in the lowest possible risk of causing a severe error of any kind. For oxygen use, the variety of materials that come into question is very much limited, since factors such as oxygen index, auto ignition temperature, heat of combustion, toxicity of fumes, risk for particle impact, etc must be considered.

O₃, oxygen cleaned – is a standard where a certain level of contaminants can be accepted to expose a tolerable risk for ignition. Special methods and detergents must be used to obtain the correct cleanliness level. Poseidon prefers to call it "cleaned for oxygen use", rather than "oxygen cleaned", which can be misleading.

O₄, oxygen approved – The European Union Directive for Personal Protective Equipment requires that SCUBA regulators must be tested and approved by an independent notified body. Regulators for oxygen use must pass more tests specifically for oxygen, e.g. adiabatic compression shock testing.

XSTREAM DEEP PACKAGE

- > Regulator
- > Neck strap
- > User guide



LP-hoses are available in a range of lengths

WHO SHOULD BUY

Deep diver, Recreational diver, Technical diver, Commercial diver

XSTREAM DURATION PACKAGE

- > Regulator
- > Neck strap
- > User guide



> Comes with G5/8 or I
LP-hoses are available in a range of lengths

WHO SHOULD BUY

Technical diver, Commercial diver

JETSTREAM

THE ULTIMATE IN RELIABILITY



SINGLE KIT JETSTREAM MK3

- > 1st Stage Xstream Regulator
- > Jetstream Octopus Yellow incl. Hose
- > Jetstream Black incl. Hose
- > With or without Pressure Gauge Black incl. Hose
- > User guide

Art. no. Description

0100-555	Single Kit Jetstream MK3
0100-556	Single Kit Jetstream MK3 incl. PSG Black

Controlling the power of a massive airflow, astonishingly reaching some 2100 litres/minute is an engineering challenge. The solution to this was to obtain a precision regulation, keeping breathing pressure to within +/- 5 mm.w.c throughout the inhalation cycle, regardless of depth and demand. Called a servo-assisted valve, it works in the same way as does the power steering you may have on your car – it's all about compensation.

Prior to diving, when you pressurize the regulator, the main blue bladder valve is inflated with the interstage pressure, along with all inner volumes including the upstream side of the servo valve. When this is done a "whooshing" sound of streaming air is heard. The system is then activated. On inhalation, the forces from the inhalation diaphragm easily overcome the light forces to crack open or "tilt" the servovalve and in turn evacuate all inner volumes. The main blue bladder valve then collapses and in turn lets an amount of gas out, corresponding to the actual demand.

This technology ensures that the lightest possible effort can result in an almost limitless amount of gas on inhalation.

All the more astonishing is the fact that Poseidon introduced this technology to the market as far back as 1981.

The Jetstream: traditionally popular with technical divers as well as the Swedish and US navies. An easy breathe at any depth, the second stage incorporates a safety valve that allows you to continue to breathe normally in the unlikely event of abnormally high pressure air being delivered to the second stage. Approved to EN250 cold water standard.

COLLECTION COLORS

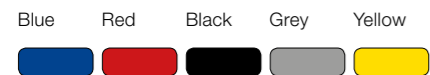

Art. no.	Description
0100-005	Jetstream, Black
0100-020	Jetstream, Blue
0100-030	Jetstream, Red
0100-080	Jetstream, Grey
0100-006	Jetstream Octopus (Yellow)



MATERIAL:

Durable PVC housing with metal mechanism and rubber parts.

TECHNICAL FEATURES:

- > Use either way up
- > Robust, durable
- > Approved for cold water diving
- > Reliable high performance

POSEIDON FACT

The Poseidon Xstream 1st Stage is the only regulator in the world that does not require environmental sealing for use in cold water.

JETSTREAM PACKAGE

- > Regulator with 70 cm hose
- > User guide

USERS

- > US Navy
- > Italian police
- > Technical divers

WHO SHOULD BUY

Sport divers
Underwater photographers

CYKLON

EVEN MORE EXPERIENCED THAN YOU...



SINGLE KIT CYKLON 5000

- > 1st Stage Cyklon Regulator
- > Cyklon Octopus Yellow incl. Hose
- > Cyklon Black incl. Hose
- > With or without Pressure Gauge Black incl. Hose
- > User guide

Art. no. Description

0100-545	Single Kit Cyklon 5000
0100-550	Single Kit Cyklon 5000 incl. PSG Black



MATERIAL:

Cyklon 5000
2nd stage in plastic.
Cyklon Metal
The same design as the Cyklon 5000, but with the 2nd stage in metal.

TECHNICAL FEATURES:

- > Use either way up
- > Robust, durable
- > Approved for cold water diving
- > Reliable high performance

A regulator must possess a set of functions which are unaffected by the different environments it will see during its lifetime. Examples of these functions include inhalation resistance, exhalation bubble distraction, noise and leak tightness – to name just a few. Different environments such as cylinder pressure, diving attitude, depth, temperature, gas, type of water, the diver can have an effect on these functions.

When a new regulator is released on the market, it has to pass the EN 250 test. This test represents one single environment; the manufacturer may have managed to test perhaps another hundred such situations, which is good but not necessarily enough. Only after years and years of actual use by divers around the world will the manufacturer collect all the information which can guarantee a perfect performance under all circumstances. This of course, takes time...

The Poseidon Cyklon Junior was introduced in 1958. In small steps, it has been gradually improved every year, based on both divers' experiences and technological evolution.

The expression "been there – done that" applies to The Poseidon Cyklon more than any other regulator on the market.

The Cyklon: First launched in 1958, constant improvements have resulted in a really tough, reliable workhorse, and is the choice of many navies around the world. Approved to EN250 cold water standard.

COLLECTION COLORS



Art. no.	Description
2981	Cyklon Octopus
2981 M	Cyklon Metal Octopus
3950	Cyklon 5000
3950 M	Cyklon Metal
3950 10	Cyklon 5000 fixed Yoke
3950 10 M	Cyklon Metal fixed Yoke

CYKLON PACKAGE

- > Regulator with 70 cm hose
- > User guide

USERS

- > German Navy
- > Swedish submarines - rescue
- > Cave divers
- > Dive schools

WHO SHOULD BUY

Sport divers
Cave divers
Anyone that want's a high performance, robust workhorse regulator

REGULATORS & GAUGES



**1 ST STAGE XSTREAM
DEEP G5/8"**

Art. no.	Description
0110-000	1st Stage Xstream Deep G5/8"
0110-010	1st Stage Xstream Deep G5/8", Black



**1 ST STAGE XSTREAM
DURATION**

Art. no.	Description
0110-001*	1st Stage Xstream Duration M26x2
0110-003*	1st Stage Xstream Duration G5/8"



**1 ST STAGE XSTREAM
OXYGEN M26X2**

Art. no.	Description
0110-002	1st Stage Xstream Oxygen M26x2



**2ND STAGE XSTREAM
9/16 BLACK/BLACK**

Art. no.	Description
0120-010	2nd Stage Xstream 9/16 Deep Black/Black



**2ND STAGE XSTREAM
9/16 DEEP MK3**

Art. no.	Description
0120-000	2nd Stage Xstream 9/16 Deep MK3



**2ND STAGE XSTREAM
9/16 DURATION**

Art. no.	Description
0120-001*	2nd Stage Xstream 9/16 Duration



**2ND STAGE XSTREAM
9/16 OCTOPUS/
BLACK OCTOPUS**

Art. no.	Description
0120-003	2nd Stage Xstream 9/16 Octopus
0120-013	2nd Stage Xstream 9/16 Black Octopus



**2ND STAGE JETSTREAM
9/16 BLACK**

Art. no.	Description
0120-005	2nd Stage Jetstream 9/16 Black



**2ND STAGE JETSTREAM
9/16 OCTOPUS**

Art. no.	Description
0120-006	2nd Stage Jetstream 9/16 Octopus



**2ND STAGE
JETSTREAM BLUE**

Art. no.	Description
0120-020*	2nd Stage Jetstream Blue



**2ND STAGE
JETSTREAM RED**

Art. no.	Description
0120-030*	2nd Stage Jetstream Red



**2ND STAGE
JETSTREAM GREY**

Art. no.	Description
0120-080*	2nd Stage Jetstream Grey



1 ST STAGE CYKLON

Art. no.	Description
3720	1st Stage Cyklon



**1 ST STAGE CYKLON
FIXED YOKE**

Art. no.	Description
3720 10*	1st Stage Cyklon Fixed Yoke



**1 ST STAGE G5/8"
FOR JETSTREAM**

Art. no.	Description
3790	1st Stage G5/8" for Jetstream



YOKE ADAPTER

Art. no.	Description
2920	Yoke adapter



**2ND STAGE CYKLON
5000 METAL/BLACK**

Art. no.	Description
3354	2nd Stage Cyklon 5000 Black
3354 M	2nd Stage Cyklon 5000 Metal/Black



**2ND STAGE CYKLON
METAL/YELLOW**

Art. no.	Description
3536	2nd Stage Cyklon Yellow
3536 M	2nd Stage Cyklon Metal/Yellow

REGULATORS & GAUGES



POSEIDON EBS MKII

The Poseidon EBS (Emergency Breathing System) is a Category A Escape device Compressed Air System.

MATERIAL:

Cylinder capacity 0.3 liter, 200 bar/2900 psi.
60 litre compressed air.
Xstream EBS mkII 1st stage regulator.
Low Pressure Hose Flexible 24".
Cyklon EBS 2nd stage regulator.

TECHNICAL FEATURES:

The EBS is complies with EN250 ColdWater and CAP1034.

COLORS

Yellow



Art. no.	Description
0140-010	Poseidon EBS Yellow



**FILLING ADAPTER
M26-G5/8" O2-CLEAN**

Art. no.	Description
0005-008*	Filling Adapter M26-G5/8" O2-Clean



**MIFLEX HOSE
POLYURETHANE**

Art. no.	Description
0130-004	LP Hose Polyurethane 9/16-18, 90cm
0130-032	LP Hose DIL 9/16-18, 20cm
0130-033	LP Hose O2 9/16-18, 20cm
0130-034	LP Hose DIL 9/16-18, 20cm w. 90 angle
0130-035	LP Hose O2 9/16-18, 20cm w. 90 angle
0132-007	LP Hose DIL 3/8M-9/16"F, 38cm
0132-008	LP Hose O2 3/8M-9/16"F, 70cm



**LP-HOSE WING
INFLATOR 80 CM**

Art. no.	Description
0130-016	LP-Hose Wing Inflator Length 80 cm



**LP-HOSE O2 WING
INFLATOR 65 CM**

Art. no.	Description
0130-026*	LP-Hose O2 Wing Inflator Length 65 cm



**LP-HOSE CYKLON
UNF 3/8"**

Art. no.	Description
2946	LP-Hose Cyklon 70 cm
2947	LP-Hose Cyklon 90 cm
2948*	LP-Hose Cyklon 120 cm
3146*	LP-Hose Cyklon 150 cm
3147*	LP-Hose Cyklon 215 cm



**LP-HOSE MK3
9/16-18**

Art. no.	Description
0130-000	LP-Hose Mk3 9/16-18 Length 70 cm
0130-001*	LP-Hose Mk3 9/16-18 Length 70 cm O2
0130-002	LP-Hose Mk3 9/16-18 Length 90 cm
0130-003*	LP-Hose Mk3 9/16-18 Length 90 cm O2
0130-006	LP-Hose Mk3 9/16-18 Length 110 cm
0130-007*	LP-Hose Mk3 9/16-18 Length 110 cm O2
0130-008	LP-Hose Mk3 9/16-18 Length 150 cm
0130-009*	LP-Hose Mk3 9/16-18 Length 150 cm O2
0130-010	LP-Hose Mk3 9/16-18 Length 215 cm
0130-011*	LP-Hose Mk3 9/16-18 Length 215 cm O2



**LP-HOSE MK3
9/16-18 BLACK**

Art. no.	Description
0130-036	LP-Hose Mk3 9/16-18 Black, Length 70 cm
0130-037	LP-Hose Mk3 9/16-18 Black, Length 90 cm

SERVO(PILOT) VALVE TECHNOLOGY

To achieve high air flow on demand, the diameter of the supply nozzle in the second stage has to be of sufficient size: however this impacts on other aspects of a regulator's design. This nozzle is covered by a plate or "valve seat", which ensures that gas does not escape when not in use or during exhalation. Force is required to hold the plate in place against the gas pressure – assuming that it is a downstream opening valve seat, as is the case in most conventional regulators. It is the force required to "crack open" the valve – the inhalation effort – which divers want to keep to a minimum.

As mentioned, with the nozzle diameter "set" according to physical laws, therefore the corresponding force to seal the nozzle is also predetermined. These laws mean that to make a high performing and enjoyable regulator, the given factors would result in either a huge diaphragm to obtain the necessary forces, or a high inhalation effort.

One solution that does reduce the inhalation effort is to use a sharp edge against the valve seat – this reduces the force needed to keep the valve closed. This is not satisfactory as it dramatically increases wear. Another option is to use Venturii-effects to fool the regulator diaphragm into believing that there is a greater demand due to local under-pressure zones near the diaphragm. However this too is not satisfactory as the Venturii-effect is dependent on depth and breathing pattern which means that performance will be affected by depth which is never good.

Our solution is Servo technology. It is like power steering in a car. A servo controlled valve is basically made of two valves; one very small and one bigger. The smaller controls the bigger. By having an extremely small valve, with a correspondingly small nozzle, the forces to keep it air-tight and therefore to open it are much smaller. In addition, since the force to keep the bigger valve shut comes from the interstage pressure itself and is controlled via the servovalve, it doesn't require sharp edged seals and it can be greatly increased in respect of outlet area to achieve very high air-flow capacity.

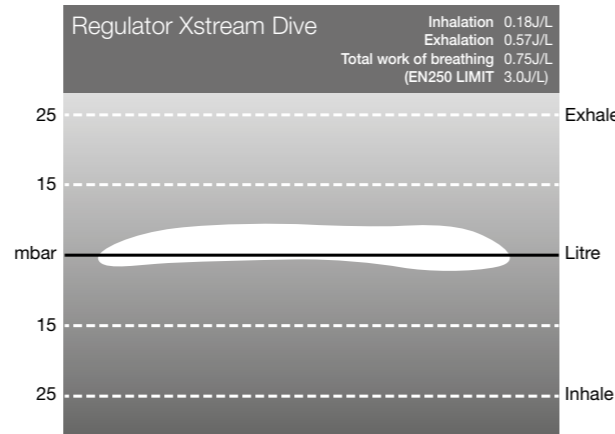

A common misconception regarding the Jetstream servo valve is that since the servo valve is an upstream opening valve, in case of an increased interstage pressure the servo will shut, preventing the main valve from opening.

This is incorrect. The Jetstream second stage is equipped with a safety valve in case a high pressure airflow occurs. This safety valve prevents the airstream from flowing out through the mouthpiece straight into your mouth. Instead, the construction will release the air into the water via the hose. In all cases it is possible to breathe from the second stage.

What is a breathing curve?

Have you ever thought of how you breathe? When you inhale and exhale you create something called a breathing curve or a loop. A breathing loop is also a way of measuring the performance of a regulator and is measured in Joules per litre (see picture). For example the total work of breathing might be 0,75J/L. The figure shown in charts is normally the sum of inhalation and exhalation with an optimised regulator in a test bench, which means it does not show if the inhalation was extremely high and exhalation extremely low or vice versa.

Some regulators rely on knobs and levers to be manually adjusted. To get optimum performance out of such a regulator as you descend or ascend is extremely hard as there are many parameters to consider. Our idea is that this should work automatically.

At Poseidon we focus on inhalation resistance as breathing out is easy for the human body. The Cyklon achieves this through overall design and the Jetstream and Xstream by servotechnology. The servo valve is unaffected by depth or what pressure it has to work at, as the force required to open it is extremely low. Next time you ask about a regulator's breathing curve ask them about inhalation resistance and if the regulator adjusts this automatically so that you don't end up being the regulator.



Regulators

General	Xstream Deep	Xstream Duration	Jetstream Mk3	Cyklon 5000	Cyklon Metal	Atmosphere FFM
Item no	0100-000	0100-001 M26 0100-007 G5/8"	0100-005	3950	3950 M	4900-M-BK
Approved to depth (m/f)	200/656 (gas dep)	200/656 (gas dep)	50/165	50/165	50/165	50/165
IP (bar/psi)	8,5/123	8,5/123	9,5/138	12/174	12/174	8,5/123
Air	✓	✓	✓	✓	✓	✓
Nitrox EAN 40%	✓	✓	n/a	n/a	n/a	n/a
Oxygen 99.95%	n/a	✓	n/a	n/a	n/a	n/a
Trimix	✓	n/a	n/a	n/a	n/a	n/a
Working pressure 300 bar	✓	✓	✓	✓	✓	✓
Anti-Freeze protection	✓	✓	**	**	**	**
O-rings	Nitril/EPDM	Viton/EPDM	Nitril	Nitril	Nitril	Nitril
US Navy Tested	✓	n/a	✓	✓	✓	n/a
Oxygen approved (EN738-1)	n/a	✓	n/a	n/a	n/a	n/a
NORSOK approved	✓	✓	n/a	n/a	n/a	n/a
EN250 approved (cold water)	✓	✓	✓	✓	✓	✓
CE Cold water approved	✓	✓	✓	✓	✓	✓

2nd Stage

Item no	0120-000	0120-001	0120-005	3354	3354 M	4915-BK
Colour	Black	Green	Black	Black	Metal	Black
Material	ASA/TPU	ASA/TPU	ASA	ASA	ASA	ASA
	Stainless steel	Stainless steel	Stainless steel	Stainless steel	Stainless steel	Stainless steel
	Brass	Brass	Brass	Brass	Brass	Brass
Weight (g/lb)	152/0,33	152/0,33	190/0,42	200/0,44	250/0,55	190/0,42
Volume (ml/cuin)	49,5/3,0	49,5/3,0	80/4,88	60/3,66	60/3,66	80/4,88
Technique	Upstream	Upstream	Upstream	Downstream	Downstream	Upstream
Flowrate (l/cuft permin)	2150/76	2150/76	1800/63	1250/44	1250/44	1800/63
Oxygen cleaned	n/a	✓	n/a	n/a	n/a	n/a
Servoassisted	✓	✓	✓	n/a	n/a	✓
Safety valve	✓	✓	✓	n/a	n/a	✓
Swiveling	✓	✓	✓	✓	✓	✓
Automatic Venturi assist	✓	✓	✓	✓	✓	✓
Automatic Inhalation control	✓	✓	✓	✓	✓	✓
Gascoded cover	✓	✓	n/a	n/a	n/a	n/a
Dismountable w/o tools	✓	✓	n/a	n/a	n/a	n/a
Non keyed (no up or down)	✓	✓	✓	✓	✓	fixed
Anatomic Mouthpiece	✓	✓	✓	✓	✓	n/a
Push button on side	✓	✓	✓	✓	✓	✓
Positive pressure	n/a	n/a	n/a	n/a	n/a	✓

1st Stage

Product name	Xstream Deep	Xstream Duration	Jetstream Mk3	Cyklon 5000	Cyklon Metal	Atmosphere Complete
Item no	0110-000	0110-001 M26 0110-003 G5/8"	0110-000	3720	3720	0110-000
Colour	Black	Green	Black	Metal	Metal	Metal
Technique	Rolling diaph.	Rolling diaph.	Diaphragm	Diaphragm	Diaphragm	Rolling diaph.
Material	Chrome/brass	Chrome/brass	Chrome/brass	Chrome/brass	Chrome/brass	Chrome/brass
Valve technique	Spheric	Spheric	Piston	Piston	Piston	Spheric
Wheel mount	Side	Side	Side	Side	Side	Side
Flowrate (l/cuft per min)	5500/194	5500/194	5500/194	5100/180	5100/180	5500/194
Oxygen cleaned DIN 5/8"	n/a	✓	✓	✓	✓	✓
Connection	✓	✓	✓	✓	✓	✓
DIN 5/8" Connection	n/a	✓	n/a	n/a	n/a	n/a
EN144-3 Connection	**	**	**	**	**	**
Separate Yoke	✓	✓	✓	n/a	n/a	n/a
Zytel HP seat	✓	✓	✓	✓	✓	✓
Safety valve	✓	✓	✓	✓	✓	✓
Thermodynamic anti-freeze prot.	✓	✓	n/a	n/a	n/a	n/a

Hose

Hose length	70 cm/28 in	*	70 cm/28 in	70 cm/28 in	70 cm/28 in	70 cm/28 in
Cordreinforced EPDM	✓	✓	✓	✓	✓	✓
Inspection port	✓	✓	✓	✓	✓	✓
>100 bar burst pressure	✓	✓	✓	✓	✓	✓
>1000 N Tensile strength	✓	✓	✓	✓	✓	✓
Oxygen cleaned	n/a	✓	n/a	n/a	n/a	n/a

Accessories

Item no	0100-003	n/a	0100-006	2981	2981 M	0100-003, 0100-006
Octopus	2920	2920	2920	2920	2920	2920
Separate Yoke	n/a	n/a	1286	1286	1286	n/a
Anti freeze cap	0130-000	0130-001	0130-000	2946	2946	0130-000
Hose 70 cm/28 inch	0130-002	0130-003	0130-002	2947	2947	0130-002
Hose 90 cm/35 inch	0130-008	0130-009	0130-008	3146	3146	0130-008
Hose 150 cm/59 inch	0130-010	0130-011	0130-010	3147	3147	0130-010
Hose 215 cm/85 inch	4540	4540	n/a	n/a	n/a	4540

* Choose length ** Accessory n/a Not available n/d Not delivered ✓ Standard

GLOSSARY OF TERMS USED

Balanced – this means that the regulated pressure is independent from the upstream pressure, e.g. IP independent from cylinder pressure, or breathing pressure independent from IP. The conventional way to obtain this is to arrange the valve in such a way that the upstream pressure either: acts only on surfaces perpendicular to the opening and closing direction, thereby having no effect on opening and closing forces; or the upstream pressure leads through the valve to an opposite surface of equal area, leading to an automatic equalisation (balancing) of forces in the opening and closing direction.

Either way, it leads to a more stable performance and higher regulating precision.

Upstream valve vs. downstream valve – an upstream valve opens in a direction opposite of the flow direction which will be established when the valve opens. A downstream opens in the same direction as the subsequent flow. An upstream valve will seal tighter and tighter with an increasing upstream pressure, while a downstream will open when upstream pressure reaches a certain threshold pressure.

SCUBA regulators with upstream valves must have something acting as a pressure relief valve somewhere in the line, to ensure that explosions are not caused in case of an excessive pressure. Downstream valves will open spontaneously, but if used, for example, in 2nd stages, will be more prone to start free-flowing under the same circumstances.

p/v loop, breathing diagram - A p/v loop is a way to visualise a regulator's breathing performance by plotting the breathing pressure over the displaced volume. Most often, the breathing starts with an inhalation to the right at the x-axis, and the inhalation forms a graph ideally close to the x-axis. When exhalation starts, the graph plotter turns and goes back again on the positive side of the x-axis until the inhaled volume has again been exhaled. This then forms a "pressure/ volume loop". The x-axis intersects with the y-axis exactly at the actual pressure at depth, and can be said to be the target regulator pressure. If both the inhalation and exhalation curve did not deviate from the target pressure whatsoever, we would have a perfect regulator, with no inhalation- or exhalation-resistance.

Norsok U-101 – Since the EN 250 standard only states-dynamic performance testing to a maximum depth of 50m, and accordingly requires a maximum approved diving limit to 50m, it cannot be used for type approving regulators capable of more. The Norwegian Off-Shore industry has established standards similar to the EN 250 which describes testing down to 400m. This standard was accepted by the notified body to be used to approve the first ever Open Circuit SCUBA regulator to be approved for use down to 200m – the Xstream. The standard can be viewed at: http://www.standard.no/pronorm-2/data/f/0/01/49/1_10704_0/U-101-N.pdf



GAUGES

The gauges come in two different colors, the traditional yellow dial and the new with a black dial. Both versions come with either bar or psi and they are also available as double console with a depth meter.

MODEL:

Cirrus Pressure Gauge with Hose



Double Console in Black



Pressure Gauge in Black



Double Console in Yellow



Manometer Mini BAR



Manometer Mini PSI



Compass Cirrus

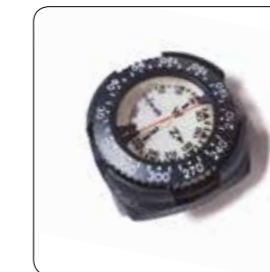

Art. no.	Description
7929	Pressure gauge Cirrus w hose BAR
0600-001	Double Console Cirrus, Black
0600-000	Pressure Gauge Cirrus, Black
8671	Double Console Cirrus w hose BAR, Yellow
001-95	Manometer Mini BAR
002-06	Manometer Mini PSI
8672*	Compass Cirrus Cover + Holster

TECHNICAL FEATURES:

Cirrus Pressure Gauge with Hose

This 300 bar (4350 psi) pressure gauge is a small model that will not be in the way during the dive. Made of robust metal and packed with Poseidon's 300 bar kevlar reinforced hose. Also available with PSI scale.

Double Console in Black

Our double console in a new design, with black display and fluorescent numbers. Pressure gauge shows both BAR and PSI. Comes with a 80 cm HP hose.

- > Black display
- > Depth gauge to 80 metres
- > Display shows both Bar and PSI

Pressure Gauge in Black

Our pressure gauge in a new design, with black display and fluorescent numbers. Pressure gauge shows both BAR and PSI. Delivered with a 80 cm HP hose.



COLLECTION COLORS

Red Black



Art. no.	Description
0337-032	Rebreather BCD Red XS
0337-033	Rebreather BCD Red S
0337-034	Rebreather BCD Red M
0337-036	Rebreather BCD Red L
0337-037	Rebreather BCD Red XL

0337-062	Rebreather BCD Black XS
0337-063	Rebreather BCD Black S
0337-064	Rebreather BCD Black M
0337-066	Rebreather BCD Black L
0337-067	Rebreather BCD Black XL

THE POSEIDON WING AND BACKPLATE

The Wing & Backplate is tailored to fit the POSEIDON SE7EN but is also an excellent choice for SCUBA diving purposes. The Poseidon Wing & Harness have been designed to sustain good buoyancy and fit. Therefore they are the preferable choice of buoyancy device.

Made in Ballistic nylon with an integrated deflate system and custom made back plate.

The webbing and buckle system is adapted from the Poseidon platform.

The black aluminum backplate is covered in Nylon for protection and a higher comfort.

The four D-rings will make it easy to attach your bailout tank/-s or anyother equipment you would like to take along on your dive.

COLLECTION COLORS

Black



Art. no.	Description
0336-164	Harness w. backplate
0338-060	Poseidon Wing WRB

TECHNICAL FEATURES:

- > Self retracting bladder
- > Three dump valves
- > Nylon covered black aluminum backplate
- > Maximum buoyancy is 150 N which is reached within 5-8 seconds
- > Dry weight 1,8 kg



MATERIAL:

Nylon 1680, Nylon covered black aluminum backplate

REBREATHER BCD

The rebreather BCD is the first of its kind and features include integrated exchangeable lungs, weight system and the Poseidon individual patch system. The rebreather BCD is constructed to the highest quality and durability using ballistic nylon, YKK zippers and hand crafted detailing. Available in 4 colors.

- > Integrated exchangeable lungs
- > Weight system
- > Individual patch system

MATERIAL:

Premium black version in Nylon 1680.
Color versions in red, made in Cordura 1000.
YKK Waterproof Zippers. Inflator with stainless steel mechanism.

TECHNICAL FEATURES:

Integrated counter lungs, Integrated weightpockets, Case for crotch strap, Velcro for patches or gauntlet.

WAIST RANGE

Size	S	M	L	XL
inch	30-36	33-39	37-43	40-47
cm	76,5-91,5	84-99	94-109	101,5-119,5

POPULAR ACCESSORIES:

Art. no.	Name	Description
0605-001/002	Display Gauntlet	Keeps your display in place on your wrist
0005-100	QMR	Quickly attached MK VI to BCD or Harness
0650-031/032/033	Wing Man	To use for your bailout bottle

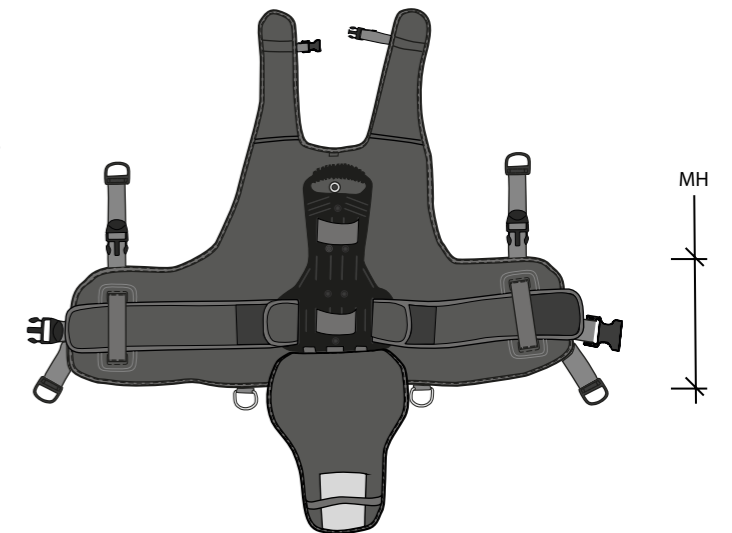

Size	W cm	H cm	MH cm
S	107,0	54,0	26,5
M	110,0	54,5	27,5
L	115,0	57,5	28,5
XL	120,0	61,0	28,5

ORIGO BCD

The Origo BCD is constructed to the highest quality and durability using ballistic nylon, YKK zippers and hand crafted detailing.

MATERIAL:

Premium black or red version in Nylon 1680.
YKK Waterproof Zippers. Inflator with stainless steel mechanism.

TECHNICAL FEATURES:

Integrated weightpockets.
Case for crotch strap,
Velcro for patches or gauntlet.

COLLECTION COLORS

Red Black



Art. no.	Description
0337-433	Origo BCD Red S
0337-434	Origo BCD Red M
0337-436	Origo BCD Red L
0337-437	Origo BCD Red XL

0337-463	Origo BCD Black S
0337-464	Origo BCD Black M
0337-466	Origo BCD Black L
0337-467	Origo BCD Black XL





ONE WING & ONE HARNESS

Poseidon's single tank wing is now available in the ONE design. Featured in 2 colors and made in Cordura™ 1000. Designed for beginners and for more experienced divers, the One Wing 50 is a sport wing with excellent volume increase and superior bladder deflation capabilities. When deflated, the ClamRetract system helps to reduce size and drag to the minimum. Four dump valves and an inflator with a stainless steel mechanism ensure inflation and deflation is always controlled and safe; and the shape of the bladder compensates for the weight of the tank when submerged and gives you freedom to move in any direction. The narrow air passage behind the neck is designed not to impede head movement or foul regulators and hoses when inflated.

The One Wing is made for equipment with a negative weight in water that does not exceed 19 kg (41.6 lbs) and has a lifting capacity of 225 N. It comes with a double, non-flex tank-band tank attachment system and can also be equipped with integrated weight pockets, accessory pockets, metal back plate, pinbolt kit and D-rings.

The standard size has a waist belt with three rows of 40 cc holes; and the large size has six rows.



COLLECTION COLORS



Art. no.	Description
0335-030	One Wing 50 Red
0335-060	One Wing 50 Black

FEATURES ONE WING:

Sport wing, Four dump valves, Inflator with a mechanism in stainless steel, Non-flex tankband, ClamRetract system.



COLLECTION COLORS



Art. no.	Description
0336-034	Harness One Red Standard
0336-036	Harness One Red Large
0336-064	Harness One Black Standard
0336-066	Harness One Black Large

FEATURES

ONE HARNESS:

Ergonomic harness, 40 cc system, Fits most sizes, Available in Standard and Large.

POSEIDON ONE HARNESS

Add system products



WEIGHT POCKET M INCL. BOLT KIT

Art. no.	Description
000-47	Weight Pocket M



ONE WING

Art. no.	Description
0335-030	One Wing 50 Red
0335-060	One Wing 50 Black



BOLT KIT BESEA BUTTERFLY

Art. no.	Description
000-93*	Bolt Kit Besea Butterfly



COMBINATION WEIGHT POCKET INCL. BOLT KIT

Art. no.	Description
0353-042	Combination Weight Pocket



BACKPLATE STEEL

Art. no.	Description
0000-256*	Backplate Steel Besea



D-RING KIT BESEA PREBENT

Art. no.	Description
001-91*	D-Ring Kit Besea Prebent



WEIGHT POCKET SYSTEM

Art. no.	Description
0355-066	Weight Pocket System



TRIM WEIGHT POCKET

Weight pocket to be used to modify the diver's trim. Easily mounted on the tank band.

COLORS

Black



Art. no.	Description
0350-010	Trim Weight Pocket

MATERIAL:

1680D Nylon in black.

TECHNICAL FEATURES:

Fits 2kg/4lbs.



WEIGHT POCKET M INCL. BOLT KIT

Quick release when you need it. Removable inner pocket for easy weight packing and removal. Pairs perfectly with Poseidon's One Harness and Rebreather Harness and Plate System.

COLORS

Black



Art. no.	Description
000-47	Weight Pocket M

MATERIAL:

Cordura with stainless bolt kit and plastic washer and release handle.

TECHNICAL FEATURES:

Symmetrical design enables placement on either left or right side. Quick-release mechanism. Removable inner pocket holds 4.5kg /10lbs. Bolt kit included.



COMBINATION WEIGHT POCKET INCL. BOLT KIT

The Black Line Combination Weight Pocket gives you everything you need in a larger weight pocket, combined with the added flexibility of using the pocket for accessories. Quick release when you need it. Removable inner pocket for easy weight packing and removal. Symmetrical design enables right or left placement. Pairs perfectly with Poseidon's One Harness and Rebreather Harness and Plate System.

COLORS

Black



Art. no.	Description
0353-042	Combination Weight Pocket

MATERIAL:

Cordura with stainless bolt kit and plastic washer and release handle.

TECHNICAL FEATURES:

Symmetrical design enables placement on either left or right side. Quick-release mechanism. Removable inner pocket holds 5kg /12lbs. Bolt kit included.



WEIGHT POCKET SYSTEM

The Black Line Weight Pocket System gives you the ultimate flexibility of fit. Quick release when you need it. Removable inner pocket for easy weight packing and removal. Symmetrical design enables right or left placement. Pairs perfectly with Poseidon's One Harness and Rebreather Harness and Plate System. Also fits with standard size weight belts.

COLORS

Black



Art. no.	Description
0355-066	Weight Pocket System

MATERIAL:

Cordura with stainless eyelets and bolt kit. Release handle in plastic.

TECHNICAL FEATURES:

Symmetrical design enables placement on either left or right side. Fits standard size weight belt as well as Poseidon BCDs. Quick-release mechanism. Removable inner pocket holds 4.5kg /10lbs. Bolt kit included.



WEIGHT BELT MEDIUM

Comfortable padded weight belt with buckle. Padding includes a soft anti slip down material for maximum comfort.

COLORS

Black



Art. no.	Description
0350-765*	Weight Belt Medium

MATERIAL:

Ballistic cordura, PP webbing, stainless eyelets, YKK #10 zipper and plastic buckle.

TECHNICAL FEATURES:

Dual zip locked pockets with 2 + 2 internal lead compartments with a max capability of 10kg (2,5kg per compartment). 2 plastic D-rings for accessories.



WEIGHT BELT LARGE

Comfortable padded weight belt with buckle. Padding includes a soft anti slip down material for maximum comfort.

COLORS

Black



Art. no.	Description
0350-767*	Weight Belt Large

MATERIAL:

Ballistic cordura, PP webbing, stainless eyelets, YKK #10 zipper and plastic buckle.

TECHNICAL FEATURES:

Dual zip locked pockets with 3 + 3 internal lead compartments with a max capability of 16kg (2,5kg per compartment). 2 plastic D-rings for accessories.



BUCKLE INCL. HOOK

Art. no.	Description
3001*	Buckle stainless steel 50 mm incl. hook



RELEASE HOOK

Art. no.	Description
3012*	Release hook 50 mm



WEIGHT STOPPING BUCKLE STEEL

Art. no.	Description
3253 10*	Weight Stopping Buckle Stainless steel 50 mm



WEIGHT STOPPING BUCKLE PLASTIC

Art. no.	Description
0310-145*	Weight Stopping Buckle Plastic 50 mm



WEIGHT BELT 50MM

Art. no.	Description
2964*	Weight Belt 50 mm

ONE SUIT SPORT (NEOPRENE)

Poseidon's versatile, multipurpose wetsuit. The range covers all aspects of diving from tropical to cold waters. The One Suit Sport is made of first grade neoprene with a jersey lining and a nylon outer shell for extra durability. The suit is based on the unique design of the One Suit Membrane and features the straight arm and leg openings for easier use with boots and gloves.

MATERIAL:

Available in 5MM Neoprene in 2 Colours: Red and Black.

TECHNICAL FEATURES:

Ultra comfortable neoprene with superstretch on sides for perfect fit, pre-bent arms and legs with smooth skin neoprene water seals for enhanced protection and comfort.



SIZE REFERENCE, CM

Men	XS	S	MS	M	MT	ML	LS	L	LT	XLS	XL	XLT	2XL	2XLT
Height	168-174	170-176	167-173	173-179	179-185	175-181	171-177	177-183	183-189	174-180	180-186	186-192	183-189	189-195
Chest	86-91	90-95	94-99	94-99	94-99	98-103	102-107	102-107	102-107	106-111	106-111	106-111	110-115	110-115
Waist	73-78	77-82	81-86	81-86	81-86	85-90	89-94	89-94	89-94	93-98	93-98	93-98	97-102	97-102
Hips	88-93	92-97	96-101	96-101	96-101	100-105	104-109	104-109	104-109	108-113	108-113	108-113	112-117	112-117

Ladies	2XS	XS	S	ST	MS	M	MT	LS	L	LT	XL	2XL
Height	160-166	162-168	164-170	170-176	160-166	166-172	172-178	162-168	168-174	174-180	170-176	172-178
Chest	76-81	80-85	84-89	84-89	88-93	88-93	88-93	92-97	92-97	92-97	96-101	100-105
Waist	60-65	64-69	68-73	68-73	72-77	72-77	72-77	76-81	76-81	76-81	80-85	84-89
Hips	82-87	86-91	90-95	90-95	94-99	94-99	94-99	98-103	98-103	98-103	102-107	106-111

SIZE REFERENCE, INCH

Men	XS	S	MS	M	MT	ML	LS	L	LT	XLS	XL	XLT	2XL	2XLT
Height	66-69	67-69	66-68	68-71	70-73	69-71	67-70	70-72	72-74	69-71	71-73	73-76	72-74	74-77
Chest	34-36	35-37	37-39	37-39	37-39	39-41	40-42	40-42	40-42	42-44	42-44	42-44	43-45	43-45
Waist	29-31	30-32	32-34	32-34	32-34	33-35	35-37	35-37	35-37	37-37	37-37	37-37	38-40	38-40
Hips	35-37	36-38	38-40	38-40	38-40	39-41	41-43	41-43	41-43	43-44	43-44	43-44	44-46	44-46

Ladies	2XS	XS	S	ST	MS	M	MT	LS	L	LT	XL	2XL
Height	63-65	64-66	65-67	67-69	63-65	65-68	68-70	64-66	66-69	69-71	67-69	68-70
Chest	30-32	31-33	33-35	33-35	35-37	35-37	35-37	36-38	36-38	36-38	38-40	39-41
Waist	24-26	25-27	27-29	27-29	28-30	28-30	28-30	30-32	30-32	30-32	31-33	33-35
Hips	32-34	34-36	35-37	35-37	37-39	37-39	37-39	39-41	39-41	39-41	40-42	42-44

COLLECTION COLORS



Art. no.	Description
0280-4320	One Suit Sport, 5mm Male Red XS
0280-4330	One Suit Sport, 5mm Male Red S
0280-4340	One Suit Sport, 5mm Male Red MS
0280-4341	One Suit Sport, 5mm Male Red M
0280-4342	One Suit Sport, 5mm Male Red MT
0280-4345	One Suit Sport, 5mm Male Red ML
0280-4350	One Suit Sport, 5mm Male Red LS
0280-4351	One Suit Sport, 5mm Male Red L
0280-4352	One Suit Sport, 5mm Male Red LT
0280-4360	One Suit Sport, 5mm Male Red XLS
0280-4361	One Suit Sport, 5mm Male Red XL
0280-4362	One Suit Sport, 5mm Male Red XLT
0280-4370	One Suit Sport, 5mm Male Red 2XL
0280-4371	One Suit Sport, 5mm Male Red 2XLT
0280-4620	One Suit Sport, 5mm Male Black XS
0280-4640	One Suit Sport, 5mm Male Black MS
0280-4642	One Suit Sport, 5mm Male Black MT
0280-4645	One Suit Sport, 5mm Male Black ML
0280-4650	One Suit Sport, 5mm Male Black LS
0280-4651	One Suit Sport, 5mm Male Black L
0280-4652	One Suit Sport, 5mm Male Black LT
0280-4660	One Suit Sport, 5mm Male Black XLS
0280-4661	One Suit Sport, 5mm Male Black XL
0280-4662	One Suit Sport, 5mm Male Black XLT
0280-4670	One Suit Sport, 5mm Male Black 2XL
0280-4671	One Suit Sport, 5mm Male Black 2XLT

Art. no.	Description
0280-5331	One Suit Sport, 5mm Female Red ST
0280-5342	One Suit Sport, 5mm Female Red MT
0280-5350	One Suit Sport, 5mm Female Red LS
0280-5351	One Suit Sport, 5mm Female Red L
0280-5352	One Suit Sport, 5mm Female Red LT
0280-5370	One Suit Sport, 5mm Female Red 2XL
0280-5610	One Suit Sport, 5mm Female Black 2XS
0280-5620	One Suit Sport, 5mm Female Black XS
0280-5630	One Suit Sport, 5mm Female Black S
0280-5631	One Suit Sport, 5mm Female Black ST
0280-5640	One Suit Sport, 5mm Female Black MS
0280-5641	One Suit Sport, 5mm Female Black M
0280-5642	One Suit Sport, 5mm Female Black LT
0280-5650	One Suit Sport, 5mm Female Black LS
0280-5651	One Suit Sport, 5mm Female Black L
0280-5652	One Suit Sport, 5mm Female Black LT
0280-5661	One Suit Sport, 5mm Female Black XL
0280-5670	One Suit Sport, 5mm Female Black 2XL



SUITS & ACCESSORIES

RASHGUARD TOP



COLLECTION COLORS



Art. no.	Description
0250-532	Rashguard Top, Male Red XS
0250-533	Rashguard Top, Male Red S
0250-534	Rashguard Top, Male Red M
0250-536	Rashguard Top, Male Red L
0250-537	Rashguard Top, Male Red XL
0250-582	Rashguard Top, Male Grey XS
0250-583	Rashguard Top, Male Grey S
0250-584	Rashguard Top, Male Grey M
0250-586	Rashguard Top, Male Grey L
0250-587	Rashguard Top, Male Grey XL
0250-562	Rashguard Top, Male Black XS
0250-563	Rashguard Top, Male Black S
0250-564	Rashguard Top, Male Black M
0250-566	Rashguard Top, Male Black L
0250-567	Rashguard Top, Male Black XL
0250-632	Rashguard Top, Female Red XS
0250-633	Rashguard Top, Female Red S
0250-634	Rashguard Top, Female Red M
0250-636	Rashguard Top, Female Red L
0250-637	Rashguard Top, Female Red XL
0250-682	Rashguard Top, Female Grey XS
0250-683	Rashguard Top, Female Grey S
0250-684	Rashguard Top, Female Grey M
0250-686	Rashguard Top, Female Grey L
0250-687	Rashguard Top, Female Grey XL
0250-662	Rashguard Top, Female Black XS
0250-663	Rashguard Top, Female Black S
0250-664	Rashguard Top, Female Black M
0250-666	Rashguard Top, Female Black L
0250-667	Rashguard Top, Female Black XL



ONE SHOE

Why you will love this product:
 Supratex neoprene for comfort and durability.
 Rear YKK zipper for easy access.
 Awesome for boards, kayaks and other watersports.

COLLECTION COLORS



MATERIAL:

Made in Supratex with rubber sole, YKK Waterproof Zipper and elastic bungy cord.

TECHNICAL FEATURES:

Step in shoe with zipper in the back, elastic bungy cord to keep the shoe slim around the divers foot, high durability sole.

Art. no.	Product Name
0251-8336	One Shoe Red/BK Toe Sz 36
0251-8337	One Shoe Red/BK Toe Sz 37
0251-8338	One Shoe Red/BK Toe Sz 38
0251-8339	One Shoe Red/BK Toe Sz 39
0251-8340	One Shoe Red/BK Toe Sz 40
0251-8341	One Shoe Red/BK Toe Sz 41
0251-8342	One Shoe Red/BK Toe Sz 42
0251-8343	One Shoe Red/BK Toe Sz 43
0251-8344	One Shoe Red/BK Toe Sz 44
0251-8345	One Shoe Red/BK Toe Sz 45
0251-8346	One Shoe Red/BK Toe Sz 46
0251-8347	One Shoe Red/BK Toe Sz 47
0251-8636	One Shoe Black/BK Toe Sz 36
0251-8637	One Shoe Black/BK Toe Sz 37
0251-8638	One Shoe Black/BK Toe Sz 38
0251-8639	One Shoe Black/BK Toe Sz 39
0251-8640	One Shoe Black/BK Toe Sz 40
0251-8641	One Shoe Black/BK Toe Sz 41
0251-8642	One Shoe Black/BK Toe Sz 42
0251-8643	One Shoe Black/BK Toe Sz 43
0251-8644	One Shoe Black/BK Toe Sz 44
0251-8645	One Shoe Black/BK Toe Sz 45
0251-8646	One Shoe Black/BK Toe Sz 46
0251-8647	One Shoe Black/BK Toe Sz 47
0251-9236	One Shoe Blue/WT Toe Sz 36
0251-9237	One Shoe Blue/WT Toe Sz 37
0251-9238	One Shoe Blue/WT Toe Sz 38
0251-9239	One Shoe Blue/WT Toe Sz 39
0251-9240	One Shoe Blue/WT Toe Sz 40
0251-9241	One Shoe Blue/WT Toe Sz 41
0251-9242	One Shoe Blue/WT Toe Sz 42
0251-9243	One Shoe Blue/WT Toe Sz 43
0251-9244	One Shoe Blue/WT Toe Sz 44
0251-9245	One Shoe Blue/WT Toe Sz 45
0251-9246	One Shoe Blue/WT Toe Sz 46
0251-9247	One Shoe Blue/WT Toe Sz 47
0251-9436	One Shoe Pink/WT Toe Sz 36
0251-9437	One Shoe Pink/WT Toe Sz 37
0251-9438	One Shoe Pink/WT Toe Sz 38
0251-9439	One Shoe Pink/WT Toe Sz 39
0251-9440	One Shoe Pink/WT Toe Sz 40
0251-9441	One Shoe Pink/WT Toe Sz 41
0251-9442	One Shoe Pink/WT Toe Sz 42
0251-9636	One Shoe Black/WT Toe Sz 36
0251-9637	One Shoe Black/WT Toe Sz 37
0251-9638	One Shoe Black/WT Toe Sz 38
0251-9639	One Shoe Black/WT Toe Sz 39
0251-9640	One Shoe Black/WT Toe Sz 40
0251-9641	One Shoe Black/WT Toe Sz 41
0251-9642	One Shoe Black/WT Toe Sz 42
0251-9643	One Shoe Black/WT Toe Sz 43
0251-9644	One Shoe Black/WT Toe Sz 44
0251-9645	One Shoe Black/WT Toe Sz 45
0251-9646	One Shoe Black/WT Toe Sz 46
0251-9647	One Shoe Black/WT Toe Sz 47



EU	36		37		38		39		40		41	
	Male	Female	Male	Female	Male	Female	Male	Female	Male	Female	Male	Female
USA		5		6	5	7	6	8	7	9	8	10
UK	4	3.5	4.5	4	5.5	5	6.5	6	7	6.5	7.5	7
CM	23,5		23,8		24,5		25,1		25,4		25,7	
EU	42		43		44		45		46		47	
	Male	Female	Male	Female	Male	Female	Male	Female	Male	Female	Male	Female
USA	9	11	10	10	11	11	12	12	13	13	14	14
UK	8	7,5	8,5	8	10	9,5	11	10,5	12	11,5	13	12,5
CM	26		26,7		27,3		27,9		29,2		29,8	



COLORS

Black



Art. no.	Description
0246-0630	Black Line Glove 5 Finger, 1.5mm S
0246-0641	Black Line Glove 5 Finger, 1.5mm M
0246-0651	Black Line Glove 5 Finger, 1.5mm L
0246-0661	Black Line Glove 5 Finger, 1.5mm XL
0246-0670	Black Line Glove 5 Finger, 1.5mm XXL

**BLACK LINE GLOVE
5 FINGER 1.5 MM**

The Glove 5 Finger 1.5 MM offers stylish protection for warm to temperate water divers.

MATERIAL:

Jako Geoprene M1 1.5 mm.

TECHNICAL FEATURES:

1.5 MM thickness for warm to temperate water thermal protection. Jako Geoprene gives you the most comfortable fit. Reinforced palms and fingers provides extra durability and protection. Patented Octopus Velcro provides strong underwater seals.



COLORS

Black



Art. no.	Description
0246-1630	Black Line Glove 5 Finger, 5mm S
0246-1641	Black Line Glove 5 Finger, 5mm M
0246-1651	Black Line Glove 5 Finger, 5mm L
0246-1661	Black Line Glove 5 Finger, 5mm XL
0246-1670	Black Line Glove 5 Finger, 5mm XXL

**BLACK LINE GLOVE
5 FINGER 5 MM**

The Glove 5 Finger 5 MM offers stylish protection for temperate to cold water divers. Jako Geoprene combines with reinforced palms and fingers to deliver good mobility with high durability and protection. Longer wrist seals combine with patented Octopus Velcro, which becomes stronger in contact with water, to help prevent water circulation and increase warmth.

MATERIAL:

Jako Geoprene M1 5 mm. Coated kevlar reinforcement.

TECHNICAL FEATURES:

5 MM thickness for temperate to cold water thermal protection. Jako Geoprene gives you the most comfortable fit. Reinforced palms and fingers provides extra durability and protection. Patented Octopus Velcro provides strong underwater seals and reduces water circulation.



COLORS

Black



Art. no.	Description
0246-2630	Black Line Glove 3 Finger, 5mm S
0246-2641	Black Line Glove 3 Finger, 5mm M
0246-2651	Black Line Glove 3 Finger, 5mm L
0246-2661	Black Line Glove 3 Finger, 5mm XL
0246-2670	Black Line Glove 3 Finger, 5mm XXL

**BLACK LINE GLOVE
3 FINGER 5 MM**

The Glove 3 Finger 5 MM offers the ultimate in cold water protection for cold water divers.

MATERIAL:

Jako Geoprene M1 5 mm. Coated kevlar reinforcement.

TECHNICAL FEATURES:

Unique 3 finger design developed in Arctic waters for ultimate thermal protection. 5 MM thickness for cold water thermal protection. Jako Geoprene gives you the most comfortable fit. Reinforced palms and fingers provides extra durability and protection. Patented Octopus Velcro provides strong underwater seals and reduces water circulation.

BLACK LINE HOOD 3 MM

The Black Line Hood 3 MM offers thermal protection for warm or temperate water divers. Jako Geoprene with an extended neck closes out as much water as possible to prevent it from circulating inside the hood.

COLORS

Black



Art. no.	Description
0245-1630	Black Line Hood, 3mm S
0245-1641	Black Line Hood, 3mm M
0245-1651	Black Line Hood, 3mm L
0245-1661	Black Line Hood, 3mm XL



MATERIAL:

Jako Geoprene M1 3 mm.

TECHNICAL FEATURES:

3 MM thickness for temperate water thermal protection. Jako Geoprene gives you the most comfortable fit. Extended neck minimizes water circulation. Taped seams give enhanced durability. Smooth skin inside for comfort and easy don and doff.

BLACK LINE HOOD 5 MM

The Black Line Hood 5 MM offers maximum thermal protection for temperate to cold water divers. Jako Geoprene with an extended neck closes out as much water as possible to prevent it from circulating inside the hood.

COLORS

Black



Art. no.	Description
0245-2630	Black Line Hood, 5mm S
0245-2641	Black Line Hood, 5mm M
0245-2651	Black Line Hood, 5mm L
0245-2661	Black Line Hood, 5mm XL



MATERIAL:

Jako Geoprene M1 5 mm.

TECHNICAL FEATURES:

5 MM thickness for temperate to cold water thermal protection. Jako Geoprene gives you the most comfortable fit. Extended neck minimizes water circulation. Taped seams give enhanced durability. Smooth skin inside for comfort and easy don and doff. Perfect for use with full face masks.

ATMOSPHERE

It is approved for cold water, and in combination with the mask features a unique highly effective de-fogging system which keeps the field of vision clear even at water temperatures close or equal to freezing point.

The mask has an anti-distortion visor, with frosted sides to prevent reflections.

The mask is an over pressure mask which reduces the risk of contaminated water entering the mask during a dive.

The mask can of course be used in all altitudes without free-flowing.



COLLECTION COLORS

Black



Art. no.	Description
4960-M-BK	Atmosphere M Complete
4900-M-BK	Atmosphere M w. 2:nd stage

Any standard communication system will fit the Poseidon mask.

The mask has external buoyancy compensating weights which can also be used for mounting torches, video-cameras etc. Developed initially for fighter plane pilots the mask was designed to be worn for up to six hours when the plane flies through chemical or biological war zones.

TECHNICAL FEATURES:

For optimum performance, the Atmosphere should be connected to an Xstream 1st stage.

- > Highly effective de-fogging system
- > Anti-distortion visor
- > Prepared for communication system

WEIGHT FOR ATMOSPHERE



Art. no.	Description
0005-195*	Weight for Atmosphere, pair



ATMOSPHERE

with Jetstream P.P. 2nd stage

Many technical divers, as well as the Swedish and American Navy, have chosen Jetstream as their favourite. The construction's simplicity guarantees high performance – as well as safety – regardless of diving conditions. This gives a regulator that is easy to breathe at any depth.

Tests conducted by the American Navy show that the Jetstream is the only regulator that, in cold water dives, manages to deliver the correct amount of air at extreme depths and rate of breathing. Jetstream also won the Swedish Navy's highest classification – of course well within the objective breathing test in cold waters.

POSEIDON FACT ATMOSPHERE

Poseidon is the only manufacturer with mouthpiece regulators approved for cold water service by US Navy. For details go to <http://www.supsalv.org/pdf/ANU.pdf>

ATMOSPHERE PACKAGE

- > Regulator with 70 cm hose
- > Warranty card
- > User guide

USERS

- > US Navy
- > Italian police
- > Technical divers

WHO SHOULD BUY

Sport divers
Under water photographers

POSEIDON FACT JETSTREAM P.P.

Jetstream P.P. fulfils the EU PPE 89/686/EEC directive and is approved according to the cold water standard EN 250:2000. The regulator has breathing performance that by far exceeds the demands of 3J/I at 50 m depth with a cylinder pressure of 50 bar.

ATMOSPHERE PACKAGE

- > Full face mask
- > Second stage with 70 cm hose
- > Warranty card
- > User guide
- > Poseidon neck strap
- > Name badge holders

WHO SHOULD BUY

Cold water divers
Public safety divers
Military
Sport divers
Technical divers

BLACK LINE MASK

High performance and high style are combined in the new Poseidon Black Line Mask, featuring LVSL® technology.

COLORS

Black



Red



Art. no.	Description
0720-160	Black Line Mask
0720-140*	Red Line Mask



MATERIAL:

Ultra clear lens.
Silicone (alt. neoprene) strap.

TECHNICAL FEATURES:

Enhanced field of vision from angled lens.
Easy to clear low volume profile.
Flood resistant extra deep, ultra soft skirt.
Works great with beards.
Poseidon's Black Line Mask was inspired by rebreather divers who need the maximum field of vision combined with a minimal gas requirement to clear the mask. To answer their needs, we developed LVSL® Low-Volume Single-Lens technology to give a unique combination of features that benefit all divers.

THREEDEE

A low volume mask that fits most faces. A robust frame and with optical lenses.

COLORS

BK/black, with black silicone
BK/kevlar, with black silicone
BK/yellow, with black silicone
BK/yellow, with clear silicone
BK/red, with black silicone
Pink/white, with clear silicone



Art. no.	Description
8700-BK BK BS	Mask 3D - Black/Black, BS
8700-BK KV BS	Mask 3D - Black/Kevlar, BS
8700-BK YW BS	Mask 3D - Black/Yellow, BS
8700-BK YW CS	Mask 3D - Black/Yellow, Clear Silicone
8700-BK RD BS	Mask 3D - Black/Red, BS
8700-PI WH CS	Mask 3D - Pink/White, Clear Silicone

8701-XX-L*	Lens Mask 3D - Left
8701-XX-R*	Lens Mask 3D - Right



MATERIAL:

Our exclusive ultra-light two-lens mask has an ultra-light polymer frame and comfort fit skirt in high quality silicone. The side buckles swivel 45 degrees and are strong and easy to adjust. Colors include matte and metallic surfaces, and 'Poseidon yellow'.

TECHNICAL FEATURES:

Prescription lenses available online.
Lens 3D from -1,5 to -9,0 in steps of 0,5.
Comfort fit suits most face shapes.
Easy to clear thanks to low volume profile.



TECHNICA

Classic mask with ultra low volume.
Very popular among technical divers and free divers.

COLORS

Black/grey



Art. no.	Description
8684-GK GA BS	Mask Technica, grey/black gomme

MATERIAL:

A compact mask with rubberised surface and double glass.



TECHNICAL FEATURES:

Perfect free-diving mask. Easy to clear, ultra-low-volume.
Stand-out rugged, stylish look.
Poseidon's Technica Mask was inspired by free-divers who need the minimum gas requirement to clear their masks. The Technica Mask's rugged looks will set you apart from the crowd and perform flawlessly. Dive after dive.



BLACK LINE SNORKEL

Lightweight. Foldable. Functional.
The new Poseidon Black Line Snorkel.

COLORS

Black



Art. no.	Description
0730-000	Black Line Snorkel

MATERIAL:

Silicone mouthpiece with TPR tube.

TECHNICAL FEATURES:

Lightweight and compact for easy travel.
Foldable design for easy storage on dives.
Wraparound design for streamlined swimming.
Perfect companion to any Poseidon Mask.



SNORKELING FIN

A shorter version of the Diving Fin,
intended for the travelling snorkeler.
Rigid rubber construction for good
force.

COLLECTION COLORS

Red Black



Art. no.	Description
0715-032	Snorkeling Fin, Red XS
0715-033	Snorkeling Fin, Red S
0715-034	Snorkeling Fin, Red M
0715-036	Snorkeling Fin, Red L
0715-037	Snorkeling Fin, Red XL
0715-062	Snorkeling Fin, Black XS
0715-063	Snorkeling Fin, Black S
0715-064	Snorkeling Fin, Black M
0715-066	Snorkeling Fin, Black L
0715-067	Snorkeling Fin, Black XL

MATERIAL:

Made from 100% rubber.



TRIDENT FIN

Ideal for those who prefer a rigid rubber
fin. Stainless steel strap for easy on and
off. One of the shortest fins of its kind
with an edge on the side for maneuver-
ability. Highly popular among technical
divers.

COLLECTION COLORS

Red Black



Art. no.	Description
0710-062	Trident Fin Red - Size M
0710-063	Trident Fin Red - Size L
0710-064	Trident Fin Red - Size XL
0710-065	Trident Fin Red - Size XXL
0710-032	Trident Fin Black - Size M
0710-033	Trident Fin Black - Size L
0710-034	Trident Fin Black - Size XL

MATERIAL:

Made from 100% rubber with rubber coated
stainless steel strap.

TECHNICAL FEATURES:

- > Short rubber fin for the technical diver
- > Easy on and off
- > Stainless steel strap with easy grip
- > High force fin with edges for maneuverability

RUBBER STRAP TRIDENT FIN

Prod. Code	Product Name
0750-001	Rubber Strap Trident Fin - White
0750-002	Rubber Strap Trident Fin - Yellow
0750-003	Rubber Strap Trident Fin - Black

STAINLESS CLIP TRIDENT FIN

Prod. Code	Product Name
0750-006	Stainless Clip Trident Fin

STAINLESS STRAP + CLIP TRIDENT FIN

Prod. Code	Product Name
0750-012	Stainless Strap+Clip Trident Fin - M - Black
0750-013	Stainless Strap+Clip Trident Fin - L - Black
0750-014	Stainless Strap+Clip Trident Fin - XL - Black
0750-015	Stainless Strap+Clip Trident Fin - XXL - Black
0750-022	Stainless Strap+Clip Trident Fin - M - Yellow
0750-023	Stainless Strap+Clip Trident Fin - L - Yellow
0750-024	Stainless Strap+Clip Trident Fin - XL - Yellow
0750-025	Stainless Strap+Clip Trident Fin - XXL - Yellow
0750-027*	Stainless Strap+Clip Trident Fin - M - Red
0750-028*	Stainless Strap+Clip Trident Fin - L - Red
0750-029*	Stainless Strap+Clip Trident Fin - XL - Red
0750-030*	Stainless Strap+Clip Trident Fin - XXL - Red



SIZE CHART, RUBBER FINs

Description	Size	USA	France	Japan	Length (cm)
 Trident Fin	M	6-8	39-41	24-25	46
Trident Fin	L	9-11	42-44	26-27	48.5
Trident Fin	XL	12-13	45-46	28-29	51
Trident Fin	XXL	13-15	46-48	30	52
 Snorkeling Fin	XS	3-5	36-38	20-23	44
Snorkeling Fin	S	5-7	38-40	23-25	46.5
Snorkeling Fin	M	7-9	40-42	25-27	49
Snorkeling Fin	L	9-11	42-44	27-29	52
Snorkeling Fin	XL	11-13	44-46	29-31	54.5



NECKSTRAP

Ultra comfortable neckstrap in 2 mm neoprene with anti-slide velcro.

COLORS

Black



Art. no.	Description
3709 06	Nackband mask neopr. Velcro

MATERIAL:

Jako neoprene in 2 mm. Available in Black with Poseidon rubber logo.

TECHNICAL FEATURES:

Anti-slide velcro patches.



MULTITOOL

Rubberised multitool with most commonly used tools for diving.

Art. no.	Description
0655-003	Multi tool Metric



PARAFFIN STICK

Art. no.	Description
0000-181	Paraffin stick 20 g



REGULATOR BAG

Art. no.	Description
7615	Regulator Bag



DAY PACK BAG

Poseidon's travel bag in ballistic nylon with water valves for wet equipment.

COLORS

Green



Art. no.	Description
0650-006	Day Pack Bag

MATERIAL:

Ballistic Nylon, Nylon straps, YKK waterproof zipper.

TECHNICAL FEATURES:

Waterproof side pockets, main pocket with holes in bottom, inside padding with additional asseccory pockets.



MASK BAG

Art. no.	Description
13003	Mask Bag



TITANIUM KNIFE

The Black Line Titanium Knife offers the ultimate combination of high quality and rugged design. The custom sheath with quick release mechanism ensures that your knife will be instantly available whenever you need it. The titanium blade and hammer tip will ensure that it is up to any task you put it to.

COLORS

Black



Art. no.	Description
0655-011	Black Line Titanium Knife

MATERIAL:

Titanium blade with TPR handle, POM sheath and neoprene harness.

TECHNICAL FEATURES:

Titanium blade for ultimate quality. Hammer tip. Quick-release polyurethane sheath with neoprene securing straps.



LINE CUTTER

Titanium line cutter with multifunction casing, both velcro and webbing.

COLORS

Titanium with black case



Art. no.	Description
0655-002	Line cutter

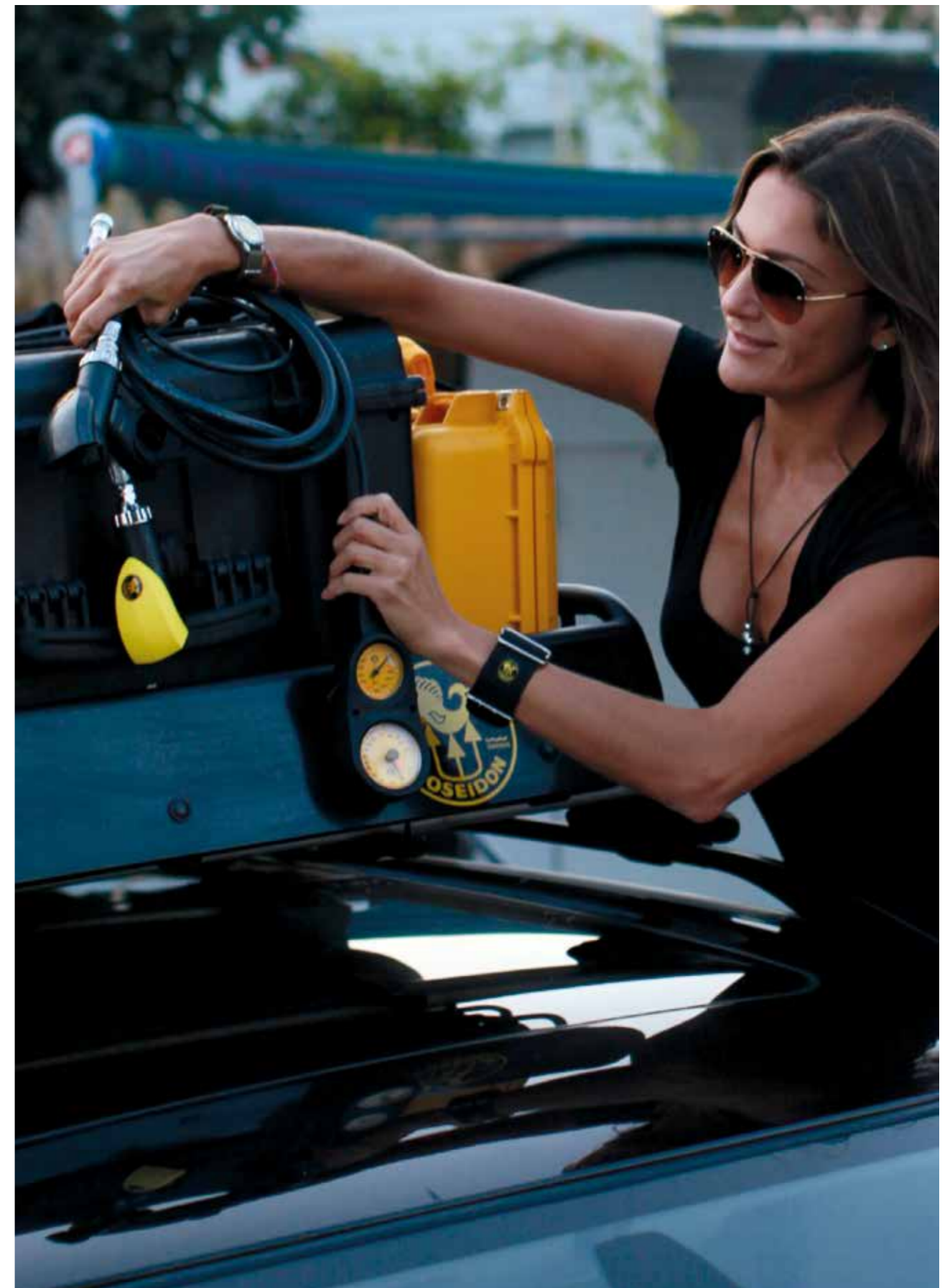



**WING MAN,
SIDE SLING BAG**

COLORS

Black



Art. no.	Description
0650-031*	Side Sling Case 7 L/55 CF
0650-032	Side Sling Case 5 L/40 CF
0650-033*	Side Sling Case 11 L/80 CF

MATERIAL:

Ballistic Nylon 1680, YKK Waterproof Zipper, Military Mesh, Octopus Velcro.



**TANK BELT BESEA
100 ADVANCED**

COLORS

Black



Art. no.	Description
000-30*	Tank Belt Besea 100 Advanced



**NECK STRAP MASK
SILICON BLACK**

Art. no.	Description
8095 01*	Neck Strap Mask Silicon Black



**CROTCH STRAP
BESEA**

COLORS

Black



Art. no.	Description
000-19*	Crotch Strap Besea



**NECK STRAP MASK
SILICON CLEAR**

Art. no.	Description
8095 02*	Neck Strap Mask Silicon Clear



**NECK STRAP
XSTREAM**

Art. no.	Description
4540*	Neck Strap Xstream



**MOUTHPIECE
INCL. STRAPS**

Art. no.	Description
0005-009	Mouthpiece incl. straps



**ANTI-FREEZE CAPS
INCL. STRAPS**

Art. no.	Description
1286	Anti-freeze Caps



**BACKPLATE STEEL
ONE HARNESS/
BESEA**

Stainless steel replacement for the plastic backplate integrated in the One Harness and adds an extra 2kg of weight.

Art. no.	Description
0000-256*	Backplate Steel Besea



**WEIGHT FOR
ATMOSPHERE**

Art. no.	Description
4944	Weight for Atmosphere, pair



**BOLT KIT
BESEA BUTTERFLY**

Art. no.	Description
000-93*	Bolt Kit Besea Butterfly



**D-RING KIT
BESEA PREBENT**

Art. no.	Description
001-91*	D-Ring Kit Besea Prebent



HOOK STAINLESS STEEL 50 MM STRAP

Art. no.	Description
P11508	Hook Stainless Steel 50 mm strap



HP-HOSE

Art. no.	Description
3087	HP-Hose 80 cm, int. 1/8" ext. 7/16"
3087 10*	HP-Hose 80 cm, int. 7/16" ext. 7/16"
3089*	HP-Hose 60 cm, int. 1/8" ext. 7/16"
3089 10*	HP-Hose 60 cm, int. 7/16" ext. 7/16"



SUIT HOSE UNF 3/8"

Art. no.	Description
3093*	Suit Hose 80 cm UNF 3/8"
3095	Suit Hose 90 cm UNF 3/8"



BRASS HOOK 50 MM STRAP

Art. no.	Description
P11507	Brass Hook 50 mm strap



HP-HOSE DIL 30CM

Art. no.	Description
0132-009	HP-Hose DIL 7/16"-7/16"F, 30cm



HP-HOSE

COLORS

Black



Art. no.	Description
1091*	HP-Hose 80 cm int. 1/8" ext. 1/8"
1092*	HP-Hose 100 cm int. 1/8" ext. 1/8"
1093*	HP-Hose 150 cm int. 1/8" ext. 1/8"
1094*	HP-Hose 200 cm G1/8" Kevlar



BRASS HOOK DOUBLE BUTTERFLY

Art. no.	Description
P250530	Brass Hook Double Butterfly



LP-HOSE BESEA ADVANCED 65 CM

Art. no.	Description
000-32	LP-Hose Besea Advanced 65 cm



LP MANIFOLD

Art. no.	Description
0000-076	LP Manifold



SWIVEL COUPLING 13 BAR ANGLE

Art. no.	Description
3289	Swivel Coupling 13 Bar Angle



SWIVEL COUPLING 13 BAR ANGLE O2

Art. no.	Description
0000-915	Swivel Coupling 13 Bar Angle O2



FILLING ADAPTER M26-G5/8" O2-CLEAN

Art. no.	Description
0005-008	Filling Adapter M26-G5/8" O2-Clean



BANJO 300 BAR UNF 7/16"

Art. no.	Description
3291*	Banjo 300 Bar UNF 7/16"



BANJO 90 HP O2-CLEAN

Art. no.	Description
0005-006	Banjo 90 HP O2-Clean



SECURITY VALVE 14 BAR UNF 3/8"

Art. no.	Description
0005-193	Security Valve 14 Bar UNF 3/8"



CONNECTION INN 3/8" OUT 1/8"

Art. no.	Description
2415	Connection int. 3/8" ext. 1/8"



CONNECTION INT 1/8" EXT 7/16"

Art. no.	Description
3137	Connection int. 1/8" ext. UNF 7/16"



SECURITY VALVE 14 BAR G1/8"

Art. no.	Description
2064	Security Valve 14 Bar G1/8"



**POSEIDON
CAP ALL GOOD**

Cap with embroidered logo.

COLORS

Black



Art. no.	Description
0040-013	Poseidon Cap All Good



**POSEIDON
CAP 58**

Cap with with Poseidon 58 text and embroidered logo back.

COLORS

Black



Art. no.	Description
0040-011	Poseidon Cap 58



**POSEIDON
POWER STRECH HAT**

COLORS

Black



Art. no.	Description
7011-BK	Poseidon Power Stretch Hat



**POSEIDON
SWEATSHIRT FISH**

Navy, with Poseidon logo Warm white

COLORS

Navy



Art. no.	Description
0040-111	Poseidon Sweatshirt Fish, Navy S
0040-112	Poseidon Sweatshirt Fish Navy M
0040-113	Poseidon Sweatshirt Fish, Navy L
0040-114	Poseidon Sweatshirt Fish, Navy XL
0040-115	Poseidon Sweatshirt Fish, Navy XXL



**POSEIDON
ZIP HOODED SWEATSHIRT**

Navy, with Poseidon logos Yellow

COLORS

Navy



Art. no.	Description
0040-103	Poseidon Zip Hooded Sweatshirt Fish, Navy S
0040-104	Poseidon Zip Hooded Sweatshirt Fish Navy M
0040-105	Poseidon Zip Hooded Sweatshirt Fish, Navy L
0040-106	Poseidon Zip Hooded Sweatshirt Fish, Navy XL
0040-107	Poseidon Zip Hooded Sweatshirt Fish, Navy XXL

POSEIDON POLO FISH

White, with Poseidon logo black.
Black, with Poseidon logo Yellow

COLORS

White



Black



Art. no.	Description
0040-087	Poseidon Polo Fish, White S
0040-088	Poseidon Polo Fish, White M
0040-089	Poseidon Polo Fish, White L
0040-090	Poseidon Polo Fish, WhiteXL
0040-091	Poseidon Polo Fish, White XXL
0040-095	Poseidon Polo Fish, Black S
0040-096	Poseidon Polo Fish, Black M
0040-097	Poseidon Polo Fish, Black L
0040-098	Poseidon Polo Fish, Black XL
0040-099	Poseidon Polo Fish, Black XXL



APPAREL



POSEIDON T-SHIRT FISH

White, with Poseidon logo Black
Navy, with Poseidon logo Yellow

COLORS



Art. no.	Description
0040-071	Poseidon T-Shirt Fish, White S
0040-072	Poseidon T-Shirt Fish, White M
0040-073	Poseidon T-Shirt Fish, White L
0040-074	Poseidon T-Shirt Fish, White XL
0040-075	Poseidon T-Shirt Fish, White XXL
0040-079	Poseidon T-Shirt Fish, Navy S
0040-080	Poseidon T-Shirt Fish, Navy M
0040-081	Poseidon T-Shirt Fish, Navy L
0040-082	Poseidon T-Shirt Fish, Navy XL
0040-083	Poseidon T-Shirt Fish, Navy XXL

Red, with Poseidon logo light Grey
Black, with Poseidon logo dark Grey



Art. no.	Description
0040-119	Poseidon T-Shirt Fish, Red S
0040-120	Poseidon T-Shirt Fish, Red M
0040-121	Poseidon T-Shirt Fish, Red L
0040-122	Poseidon T-Shirt Fish, Red XL
0040-123	Poseidon T-Shirt Fish, Red XXL
0040-127	Poseidon T-Shirt Fish, Black S
0040-128	Poseidon T-Shirt Fish, Black M
0040-129	Poseidon T-Shirt Fish, Black L
0040-130	Poseidon T-Shirt Fish, Black XL
0040-131	Poseidon T-Shirt Fish, Black XXL



APPAREL

POSEIDON 60TH ANNIVERSARY T-SHIRTS



COLORS



Art. no.	Description
0040-143	Poseidon T-Shirt Cyklon Zebra, White S
0040-144	Poseidon T-Shirt Cyklon Zebra, White M
0040-145	Poseidon T-Shirt Cyklon Zebra, White L
0040-146	Poseidon T-Shirt Cyklon Zebra, White XL
0040-147	Poseidon T-Shirt Cyklon Zebra, White XXL



Art. no.	Description
0040-159	Poseidon T-Shirt Aqua-Sport Zebra, Black S
0040-160	Poseidon T-Shirt Aqua-Sport Zebra, Black M
0040-161	Poseidon T-Shirt Aqua-Sport Zebra, Black L
0040-162	Poseidon T-Shirt Aqua-Sport Zebra, Black XL
0040-163	Poseidon T-Shirt Aqua-Sport Zebra, Black XXL



COLORS



Art. no.	Description
0040-135	Poseidon T-Shirt Don't Suck, White S
0040-136	Poseidon T-Shirt Don't Suck, White M
0040-137	Poseidon T-Shirt Don't Suck, White L
0040-138	Poseidon T-Shirt Don't Suck, White XL
0040-139	Poseidon T-Shirt Don't Suck, White XXL



Art. no.	Description
0040-151	Poseidon T-Shirt Cyklon, Navy S
0040-152	Poseidon T-Shirt Cyklon, Navy M
0040-153	Poseidon T-Shirt Cyklon, Navy L
0040-154	Poseidon T-Shirt Cyklon, Navy XL
0040-155	Poseidon T-Shirt Cyklon, Navy XXL

DISCONTINUED PRODUCTS

The number and sizes may be limited. Check availability to order.

ONE SUIT SPORT (NEOPRENE)

Poseidon's versatile, multipurpose wetsuit. The range covers all aspects of diving from tropical to cold waters. The One Suit Sport is made of first grade neoprene with a jersey lining and a nylon outer shell for extra durability. The suit is based on the unique design of the One Suit Membrane and features the straight arm and leg openings for easier use with boots and gloves.

MATERIAL:

Available in 5MM Neoprene in 2 Colours: Blue and Grey.

TECHNICAL FEATURES:

Ultra comfortable neoprene with superstretch on sides for perfect fit, pre-bent arms and legs with smooth skin neoprene water seals for enhanced protection and comfort.



SIZE REFERENCE, CM

Men	XS	S	MS	M	MT	ML	LS	L	LT	XLS	XL	XLT	2XL	2XLT
Height	168-174	170-176	167-173	173-179	179-185	175-181	171-177	177-183	183-189	174-180	180-186	186-192	183-189	189-195
Chest	86-91	90-95	94-99	94-99	94-99	98-103	102-107	102-107	102-107	106-111	106-111	106-111	110-115	110-115
Waist	73-78	77-82	81-86	81-86	81-86	85-90	89-94	89-94	89-94	93-98	93-98	93-98	97-102	97-102
Hips	88-93	92-97	96-101	96-101	96-101	100-105	104-109	104-109	104-109	108-113	108-113	108-113	112-117	112-117

Ladies	2XS	XS	S	ST	MS	M	MT	LS	L	LT	XL	2XL
Height	160-166	162-168	164-170	170-176	160-166	166-172	172-178	162-168	168-174	174-180	170-176	172-178
Chest	76-81	80-85	84-89	84-89	88-93	88-93	88-93	92-97	92-97	92-97	96-101	100-105
Waist	60-65	64-69	68-73	68-73	72-77	72-77	72-77	76-81	76-81	76-81	80-85	84-89
Hips	82-87	86-91	90-95	90-95	94-99	94-99	94-99	98-103	98-103	98-103	102-107	106-111

SIZE REFERENCE, INCH

Men	XS	S	MS	M	MT	ML	LS	L	LT	XLS	XL	XLT	2XL	2XLT
Height	66-69	67-69	66-68	68-71	70-73	69-71	67-70	70-72	72-74	69-71	71-73	73-76	72-74	74-77
Chest	34-36	35-37	37-39	37-39	37-39	39-41	40-42	40-42	40-42	42-44	42-44	42-44	43-45	43-45
Waist	29-31	30-32	32-34	32-34	32-34	33-35	35-37	35-37	35-37	37-37	37-37	37-37	38-40	38-40
Hips	35-37	36-38	38-40	38-40	38-40	39-41	41-43	41-43	41-43	43-44	43-44	43-44	44-46	44-46

Ladies	2XS	XS	S	ST	MS	M	MT	LS	L	LT	XL	2XL
Height	63-65	64-66	65-67	67-69	63-65	65-68	68-70	64-66	66-69	69-71	67-69	68-70
Chest	30-32	31-33	33-35	33-35	35-37	35-37	35-37	36-38	36-38	36-38	38-40	39-41
Waist	24-26	25-27	27-29	27-29	28-30	28-30	28-30	30-32	30-32	30-32	31-33	33-35
Hips	32-34	34-36	35-37	35-37	37-39	37-39	37-39	39-41	39-41	39-41	40-42	42-44

DISCONTINUED PRODUCTS

The number and sizes may be limited. Check availability to order.

COLLECTION COLORS



Art. no.	Description
0280-4220	One Suit Sport, 5mm Male Blue XS
0280-4230	One Suit Sport, 5mm Male Blue S
0280-4240	One Suit Sport, 5mm Male Blue MS
0280-4242	One Suit Sport, 5mm Male Blue MT
0280-4245	One Suit Sport, 5mm Male Blue ML
0280-4251	One Suit Sport, 5mm Male Blue L
0280-4252	One Suit Sport, 5mm Male Blue LT
0280-4260	One Suit Sport, 5mm Male Blue XLS
0280-4262	One Suit Sport, 5mm Male Blue XLT
0280-4270	One Suit Sport, 5mm Male Blue 2XL
0280-4271	One Suit Sport, 5mm Male Blue 2XLT
0280-4820	One Suit Sport, 5mm Male Grey XS
0280-4830	One Suit Sport, 5mm Male Grey S
0280-4840	One Suit Sport, 5mm Male Grey MS
0280-4841	One Suit Sport, 5mm Male Grey M
0280-4842	One Suit Sport, 5mm Male Grey MT
0280-4845	One Suit Sport, 5mm Male Grey ML
0280-4850	One Suit Sport, 5mm Male Grey LS
0280-4851	One Suit Sport, 5mm Male Grey L
0280-4852	One Suit Sport, 5mm Male Grey LT
0280-4860	One Suit Sport, 5mm Male Grey XLS
0280-4861	One Suit Sport, 5mm Male Grey XL
0280-4862	One Suit Sport, 5mm Male Grey XLT
0280-4870	One Suit Sport, 5mm Male Grey 2XL
0280-4871	One Suit Sport, 5mm Male Grey 2XLT

Art. no.	Description
0280-5210	One Suit Sport, 5mm Female Blue 2XS
0280-5220	One Suit Sport, 5mm Female Blue XS
0280-5231	One Suit Sport, 5mm Female Blue ST
0280-5240	One Suit Sport, 5mm Female Blue MS
0280-5241	One Suit Sport, 5mm Female Blue M
0280-5242	One Suit Sport, 5mm Female Blue MT
0280-5250	One Suit Sport, 5mm Female Blue LS
0280-5251	One Suit Sport, 5mm Female Blue L
0280-5252	One Suit Sport, 5mm Female Blue LT
0280-5261	One Suit Sport, 5mm Female Blue XL
0280-5270	One Suit Sport, 5mm Female Blue 2XL
0280-5610	One Suit Sport, 5mm Female Black 2XS
0280-5620	One Suit Sport, 5mm Female Black XS
0280-5630	One Suit Sport, 5mm Female Black S
0280-5631	One Suit Sport, 5mm Female Black ST
0280-5640	One Suit Sport, 5mm Female Black MS
0280-5641	One Suit Sport, 5mm Female Black M
0280-5642	One Suit Sport, 5mm Female Black MT
0280-5650	One Suit Sport, 5mm Female Black LS
0280-5651	One Suit Sport, 5mm Female Black L
0280-5652	One Suit Sport, 5mm Female Black LT
0280-5661	One Suit Sport, 5mm Female Black XL
0280-5670	One Suit Sport, 5mm Female Black 2XL

DISCONTINUED PRODUCTS

The number and sizes may be limited. Check availability to order.

We are reducing the color range on certain products. The following products have been discontinued in blue and grey, but will be continued in red and black.

PROTECTION HANDLE



The Stainless steel handle is easily mounted on top of your Poseidon MKVI. This will make your rebreather easy to grab and carry.

Art. no.	Description
0005-065	Protection handle Discovery

MATERIAL:

Stainless Steel

TECHNICAL FEATURE:

Quick mount/dismount

TECHNICA SNORKEL



Designed with comfort and heavy usage in mind, the Technica Snorkel delivers rugged dependability.

COLORS

Black

Art. no.	Description
0730-002	Technica Snorkel

MATERIAL:

Silicone mouthpiece with TPR tube.

REBREATHER BCD



COLLECTION COLORS

Blue Grey



Art. no.	Description
0337-022	Rebreather BCD Blue XS
0337-023	Rebreather BCD Blue S
0337-024	Rebreather BCD Blue M
0337-026	Rebreather BCD Blue L
0337-027	Rebreather BCD Blue XL
0337-082	Rebreather BCD Grey XS
0337-083	Rebreather BCD Grey S
0337-084	Rebreather BCD Grey M
0337-086	Rebreather BCD Grey L
0337-087	Rebreather BCD Grey XL

BUCKLE INCL. HOOK



Art. no.	Description
3000	Buckle stainless steel 40 mm incl. hook

WING BESEA D100 & W100



COLLECTION COLORS

Black



Art. no.	Description
000-40	Wing Besea D100
0334-000	Wing Besea W100

For technical diving the W100 or the D100 is the right choice. The W100 is a single bladder tech-wing purpose-designed. The D100 is a dual bladder tech-wing for divers requiring redundancy. The W100/D100 is made for equipment with a negative weight in water that does not exceed 30 kg, with a lifting capacity of 368 N.

The air passage behind the neck is narrow enough to avoid pushing the head forward or interfering with the regulator and hoses when inflated.



RELEASE HOOK

Art. no.	Description
3011	Release hook 40 mm

DISCONTINUED PRODUCTS

The number and sizes may be limited. Check availability to order.



SNORKELING FIN

A shorter version of the Diving Fin, intended for the travelling snorkeler. Rigid rubber construction for good force.

COLLECTION COLORS

Blue Grey



Art. no.	Description
0715-022	Snorkeling Fin, Blue XS
0715-023	Snorkeling Fin, Blue S
0715-024	Snorkeling Fin, Blue M
0715-026	Snorkeling Fin, Blue L
0715-027	Snorkeling Fin, Blue XL
0715-082	Snorkeling Fin, Grey XS
0715-083	Snorkeling Fin, Grey S
0715-084	Snorkeling Fin, Grey M
0715-086	Snorkeling Fin, Grey L
0715-087	Snorkeling Fin, Grey XL

MATERIAL:

Made from 100% rubber.



IPAD CASE

Waterproof casing for iPad available in black Nylon 1680.

COLORS

Black



Art. no.	Description
0650-010	iPad Case Black

SIZE CHART, SNORKELING/RUBBER FINNS

Description	Size	USA	France	Japan	Length (cm)
Snorkeling Fin	XXXS	12-1	32-34	16-18	40
Snorkeling Fin	XXS	1-3	34-36	18-20	42
Snorkeling Fin	XS	3-5	36-38	20-23	44
Snorkeling Fin	S	5-7	38-40	23-25	46.5
Snorkeling Fin	M	7-9	40-42	25-27	49
Snorkeling Fin	L	9-11	42-44	27-29	52
Snorkeling Fin	XL	11-13	44-46	29-31	54.5
Snorkeling Fin	XXL	13-15	46-48	31-33	57



LAPTOP CASE

Waterproof casing for Laptops 15" and 17". Made in Nylon 1680.

COLORS

Black



Art. no.	Description
0650-011	Laptop Case Black

POSEIDON DIVING SYSTEMS AB

Åkeredsvägen 1
421 63 Västra Frölunda
SWEDEN

E-mail: sales@poseidon.com
order@poseidon.com
Phone: +46 31 734 29 00

order.poseidon.com
www.poseidon.com

POSEIDON AMERICAS

14914 S. Figueroa Street
Gardena, CA 90248
USA

E-mail: usa@poseidon.com
Phone: (310) 821-8800

usa.poseidon.com



www.poseidon.com