

# DIVE SUPPLY

CATALOGUE  
2021



**DIVE**  
SUPPLY



NEW SUUNTO D5

COPPER

SUUNTO

Adventure starts here



DIVE life  
Made easy.  
Adventure underwater.  
Connect above the surface.  
Suunto D5, explore together.

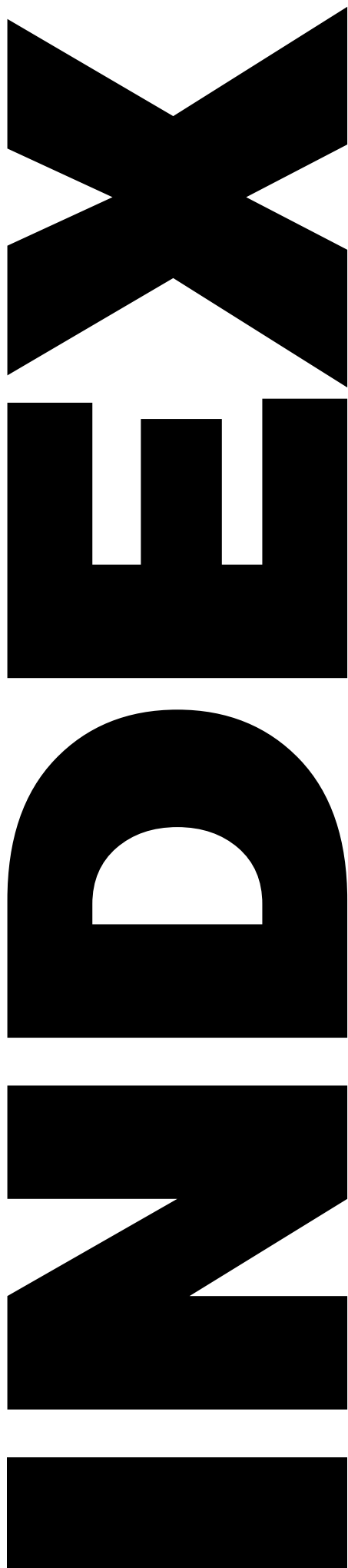

<b>REGULATORS</b>	<b>2-7</b>
<b>BCD'S</b>	<b>8-12</b>
<b>INSTRUMENTS</b>	<b>13-15</b>
<b>DIVE COMPUTERS</b>	<b>16-19</b>
<b>MASKS &amp; SNORKELS</b>	<b>20-25</b>
<b>GOGGLES &amp; MASK SETS</b>	<b>26-28</b>
<b>FINS</b>	<b>29-30</b>
<b>Boots &amp; Gloves</b>	<b>31</b>
<b>Wetsuit &amp; Lycra</b>	<b>32-35</b>
<b>CAMERAS</b>	<b>36-37</b>
<b>BAGS &amp; CASES</b>	<b>38-42</b>
<b>TORCHES</b>	<b>43</b>
<b>DIVE KNIVES</b>	<b>44-45</b>
<b>ACCESSORIES</b>	<b>46-54</b>
<b>TOOLS &amp; SERVICE PARTS</b>	<b>55-56</b>
<b>TANKS, VALVES &amp; AIR</b>	<b>57-59</b>
<b>COMPRESSORS</b>	<b>60-61</b>
<b>MARINE BOOKS</b>	<b>62</b>
<b>CUSTOM PRINTS &amp; EMBROIDERY</b>	<b>63</b>
<b>SHOP DISPLAYS / FITTINGS</b>	<b>64-65</b>

## HIGH TECHNOLOGY & MAXIMUM BREATHING COMFORT WITH SCUBAPRO REGULATORS

### SCUBAPRO FIRST STAGE REGULATORS

First stage regulators are divided into piston & diaphragm categories.

#### SCUBAPRO PISTON TECHNOLOGY

The general advantage of a piston first stage lies in its reliability & reduced maintenance requirements. More importantly, no other design can reach the high air delivery rate of a balanced piston controlled first stage. First stages with air-balanced pistons deliver significantly more air to the second stage than any other first stage. This technology is featured in our MK25 EVO first stages.

Classic downstream piston - The classic downstream valve is the first choice of diving centers & rental facilities worldwide for warm & moderate water temperatures. This technology is featured in our MK2 EVO first stage.

## FIRST STAGE



PRODUCT FEATURES	MK25T EVO	MK25 EVO	MK21	MK2 EVO	MK17 EVO	MK19 EVO	MK11
<b>Technology</b>							
Air-balanced-flow-through •	•	•	•				
Classic downstream				•			
balanced diaphragm					•	•	•
<b>Materials</b>							
Chrome plated brass body		•	•	•	•	•	•
Full titanium body	•						
<b>Cold water</b>							
Anti-freeze protection (AF)	•	•	•		•		
Dry chamber					•	•	
XTIS antifreeze system	•	•		•		•	
<b>Ports</b>							
Intermediate pressure Ports (IP)	5	5	4	4	4	5	4
High Flow Ports (HFP)	5	5	4	-	2	5	2
High Pressure (HP) Ports	2	2	2	1	2	2	2
Swivelling turret with IP ports	•	•				•	
Cap with 5 HFP ports (optional)			•				
<b>Configuration</b>							
INT 230 bar (3336 psi)	•	•	•	•	•	•	•
DIN 300 bar (4351 psi)	•	•	•	•	•	•	•
Externally adjustable intermediate pressure	•	•	•		•		•
Weight DIN 300 (g/oz)	350 / 12.4	572 / 20.1	555 / 19.6	454 / 16	625 / 22	678 / 23.9	470 / 16.6
Weight INT (g/oz)	480 / 16.9	790 / 27.9	744 / 26.2	673 / 23.7	850 / 30	898 / 31.7	692 / 24.4
Air Flow at 200 bar (l/min / SCFM)	>8500 / 301	>8500 / 301	>7500 / 265	3000 / 106	>6500 / 230	>6900 / 244	>5500 / 195
Intermediate pressure (bar/psi)	9-9.8/ 130-142	9-9.8/ 130-142	9-9.8/ 130-142	8.5-9.8/ 123-142	9-9.8/ 130-142	9.2-9.8/ 133-142	9-9.8/ 130-142



• **SCUBAPRO DIAPHRAGM TECHNOLOGY**

Diaphragm-based first stages are environmentally sealed so water cannot enter the inner mechanism. Diaphragm first stages have been the favored choice of cold water divers & those working in contaminated or muddy water. This technology is featured in our MK17 EVO & MK11 first stages.

• **SCUBAPRO SECOND STAGE REGULATORS**

A high quality second stage can significantly reduce stress & enhance diver safety by providing a smooth, low-effort breathing response, resulting in ample yet controllable quantities of air.

• **AIR-BALANCED VALVE TECHNOLOGY**

The air-balanced valve technology of SCUBAPRO second stages features a balancing chamber in the second stage mechanism, slightly offsetting the force of the downstream air entering from the first stage. Air-balanced valve technology is featured in X-Series, S-Series & G-Series second stages. For best results, they should be teamed with balanced first stages like the MK25 EVO or MK17 EVO.

# SECOND STAGE



PRODUCT FEATURES	A700	S600	S560	D420	C370	G260	R195	R095
<b>Technology</b>								
Air-balanced	•	•	•	•	•	•		
Classic downstream valve							•	•
<b>Materials</b>								
Precision molded carbon fiber & technopolymer housing			•		•			
Full metal valve housing	•	•		•		•	•	•
Full metal case	•							
<b>Breathing comfort</b>								
Coaxial flow	•				•			
Diver's adjustable inhalation effort	•	•	•		•	•		
Diver's adjustable VIVA	•	•	•	•	•	•	•	
VIVA preset								•
<b>Hose</b>								
Sturdy super-flow hose for extra durability & flawless air delivery	•	•	•		•	•	•	•
Left & right attachment for extra convenience				•		•	•	•
<b>Mouthpiece</b>								
Supercomfort HF (High Flow)	•	•	•	•	•	•	•	•
Weight (g/oz)	265 / 9.3	193 / 6.8	172 / 6.1	216 / 7.6	158 / 5.6	275 / 9.7	198 / 7.0	165 / 5.8
Air Flow at 200 bar (l/min / SCFM)	>2000 / 71	1850 / 66	1850 / 66		1850 / 66	18000 / 64	1400 / 50	1400 / 50

## MK25 EVO / A700 CARBON BLACK TECH



X12.770.700

### First stage

- DLC (Diamond-like Carbon) black finish
- Cold water XTIS (external thermal insulating system)
- Improved cold water performance by 30% in waters down to 2°C

### Second stage

- Precision handcrafted construction (full metal case)
- NEW carbon fibre cover that's virtually bulletproof
- Exceptional breathing performance at any depth
- Diver adjustable venturi-initiated vacuum assist (VIVA)
- High comfort orthodontic mouthpiece

## MK25 EVO / G260 BLACK TECH



X12.771.500

### First stage

- Durable Black Tech Coating with Diamond Like Carbon finish.
- Air Balanced Flow Through Piston
- Extended Thermal Insulating System
- 5 High Flow Low Pressure Ports
- 2 High Pressure Ports

### Second stage

- Reinforced, Black Tech, Techno Polymer Design
- Air Balanced Second Stage
- Dive Adjustable Inhalation Effort Control and VIVA

## MK25T EVO / S620X TITANIUM



X12.620.400

### First stage

- Titanium construction
- Cold water XTIS (external thermal insulating system)
- Improved cold water performance by 30% in waters down to 2°C

### Second stage

- Rugged reinforced technopolymer case
- Titanium barrel
- New exhaust tee increases performance while directing bubbles out of the field of view
- Compact Hi-Flow mouthpiece, exclusive to the S620 Ti - improved airflow & mouth comfort

## MK25 EVO / D420



X12.420.000

### First stage

- Double chrome plated marine brass
- Cold water XTIS (external thermal insulating system)
- Improved cold water performance by 30% in water down to 2°C

### Second stage

- NEW. Uniquely shaped casing carries on the D-Series heritage with the latest advances in breathing performance technology
- NEW. Air-balanced Progressive Flow Control Valve is able to deliver abundant airflow with a natural smoothness comparable to breathing on the surface
- NEW casing design features inner winglets that direct airflow towards the exhaust valve, creating a dramatic improvement in exhalation effort
- NEW. Diaphragm is located in the lower section of the casing to take advantage of the pressure gradient in the upright position, making breathing even easier

## MK25 EVO / S600



X12.971.050

### First stage

- Double chrome plated marine brass
- Cold water XTIS (external thermal insulating system)
- Improved cold water performance by 30% in water down to 2°C

### Second stage

- Technopolymer body & components
- Diver adjustable venturi-initiated vacuum assist (VIVA)
- High comfort orthodontic mouthpiece

## MK19 EVO / D420



X12.425.000

### First stage

- Air balanced diaphragm delivers constant & effortless airflow unaffected by depth, tank pressure, or breathing rate
- Dry ambient pressure chamber increases freezing resistance, ensuring consistent airflow in the coldest conditions
- Environmentally sealed system prevents water & pollutants from fouling the inner mechanism
- Five high-flow low pressure ports on a swivel turret maximize hose routing options (same as MK25)
- Double high pressure outlets

### Second stage

- NEW. Uniquely shaped casing carries on the D-Series heritage with the latest advances in breathing performance technology
- NEW. Air-balanced Progressive Flow Control Valve is able to deliver abundant airflow with a natural smoothness comparable to breathing on the surface
- NEW casing design features inner winglets that direct airflow towards the exhaust valve, creating a dramatic improvement in exhalation effort
- NEW. Diaphragm is located in the lower section of the casing to take advantage of the pressure gradient in the upright position, making breathing even easier

DEEP DOWN  
YOU WANT THE BEST





## MK19 EVO / G260

### CARBON BLACK TECH



#### First stage

- Lightweight carbon fiber design.
- Increased resistance to freezing from internal metal componentry.
- Large casing and diaphragm on second stage for improved breathing sensitivity.
- Diver-adjustable inhalation effort knob fine-tunes air delivery.
- VIVA dive/pre-dive switch prevents free flows.
- Super-flow hose.
- High-flow exhaust valve reduces exhalation effort.
- Convenient large purge button.
- Easy to grip orthodontic mouthpiece.
- Available in DIN or INT configuration.

#### Second stage

- Smaller and compact first stage.
- Air-balanced diaphragm delivering constant and effortless airflow.
- Environmentally sealed system.
- New dry chamber is equipped with a double spring making it compact and reliable.
- Two high pressure ports.
- Swivel turret with four High-Flow low pressure ports and one axial Super High-Flow low pressure port.

DIN...X12.719.600 INT...X12.719.500

## SIDEMOUNT REGULATOR SET



X12.252.060

Offering effortless air delivery and outstanding reliability, this is the go-to air delivery system for cold water or technical diving. There's no better example of solid first stage performance in all water temperatures than the MK25 EVO. Teamed with the venerable G260, this system can be relied upon to deliver top-of-the-line performance in the most extreme conditions.

#### Set Contains

- 2 x MK25 EVO DIN 300
- 2 x G260
- 2 x Compact Gauges

#### Plus

- 2 x HP hose 20cm
- LP hoses: 20cm (x2), 64cm (x1), 200cm (x1)
- BPI quick coupling x 2
- LP hose elbow x 1
- Regulator Necklace x 1
- Plug x 2

## MK17 EVO / S600



X12.927.050

#### First stage

- Air balanced diaphragm
- New machined body
- 4 high flow LP ports & 2 HP ports
- Environmentally sealed mechanism
- New cover & caps

#### Second stage

- Technopolymer body & components
- Diver adjustable venturi-initiated vacuum assist (VIVA)
- High comfort orthodontic mouthpiece

## MK21 / C370



X12.979.000

#### First stage

- Compact design 20% smaller than the MK25
- Air-balanced flow through piston design
- Optional replaceable head ideal for technical diving
- 4 LP ports & 2 HP ports

#### Second stage

- Compact body & exhaust tee
- Optimal flow design incorporates a special barrel & balanced poppet valve to produce maximum airflow under any diving conditions
- Diver-adjustable inhalation effort
- Venturi-Initiated Vacuum Assist (VIVA)
- Ultra-comfortable orthodontic mouthpiece

## MK21 / S560



X12.974.000

#### First stage

- Compact design 20% smaller than the MK25
- Air-balanced flow through piston design
- Optional replaceable head ideal for technical diving
- 4 LP ports & 2 HP ports

#### Second stage

- Lightweight techno-polymer barrel
- Diver adjustable inhalation effort
- Diver-adjustable venturi-initiated vacuum assist (VIVA)
- Ultra comfortable orthodontic mouthpiece

## MK11 / C370



X12.175.000

#### First stage

- Balanced diaphragm design
- Cold water - anti-freeze protection
- Chrome plated brass body in compact design
- 4 LP ports & 2 HP ports

#### Second stage

- Compact body & exhaust tee
- Optimal flow design incorporates a special barrel & balanced poppet valve to produce maximum airflow under any diving conditions
- Diver-adjustable inhalation effort
- Venturi-Initiated Vacuum Assist (VIVA)
- Ultra-comfortable orthodontic mouthpiece

## MK2 EVO / R095

SCUBAPRO



X12.096.000

### First stage

- Increased performance at low tank pressure
- Cold water XTIS (external thermal insulating system)
- Improved positioning – 5% reduced in length
- New piston design with 15% increased airflow

### Second stage

- Classic downstream valve
- Preset VIVA
- Reversible LP hose attachment

## MK2 EVO / R195

SCUBAPRO



X12.118.000

### First stage

- Increased performance at low tank pressure
- Cold water XTIS (external thermal insulating system)
- Improved positioning – 5% reduced in length
- New piston design with 15% increased airflow

### Second stage

- Classic downstream valve
- Diver-adjustable venturi-initiated vacuum assist (VIVA)
- Reversible hose attachment
- Super-flow hose
- Super comfort orthodontic mouthpiece
- Metal valve housing

## MK2 EVO

SCUBAPRO

BEST SELLER



INT (Yoke)...X10.063.000  
DIN...X10.063.300



- NEW XTIS (external thermal insulating system)
- Industry renowned 'workhorse' regulator for Dive Schools
- New piston design with 15% increased airflow
- 50% increase in freezing resistance
- 4 LP ports & 1 HP port

## MK11

SCUBAPRO



INT (Yoke)...X10.708.000  
DIN...X10.708.300

- Balanced diaphragm design
- Cold water – anti-freeze protection
- Chrome plated brass body in compact design
- 4 LP ports & 2 HP ports

## MK21

SCUBAPRO



INT (Yoke)...X10.721.000  
DIN...X10.721.300

- Compact design 20% smaller than the MK25
- Air-balanced flow through piston design
- Optional replaceable head ideal for technical diving
- 4 LP ports & dual HP ports
- Adjustable intermediate pressure

## MK25 EVO

SCUBAPRO



INT (Yoke)...X10.713.010  
DIN...X10.713.030

- Consistently ranked as the top performing first stage
- Air-balanced flow through piston design
- NEW XTIS (external thermal insulating system)
- 30% increase in freezing resistance
- 5 extra high airflow LP ports on a rotating turret
- 2 HP ports

## A700

SCUBAPRO



X11.700.000

- Precision handcrafted construction with polished chrome exterior & full metal case
- Air balanced valve & coaxial flow
- Diver-adjustable inhalation effort
- Diver-adjustable venturi-initiated vacuum assist (VIVA)
- Super-flow hose & high comfort orthodontic mouthpiece

## S600

SCUBAPRO



X11.603.000

- Air balanced flow valve
- Diver-adjustable venturi-initiated vacuum assist (VIVA)
- Diver-adjustable inhalation effort
- Full metal valve housing
- Super-flow hose
- High comfort orthodontic mouthpiece

## MK17 EVO

SCUBAPRO



INT (Yoke)...X10.714.010  
DIN...X10.714.030

- Air balanced diaphragm
- New machined body
- 4 high flow LP port & 2 HP ports
- Environmentally sealed mechanism
- New cover & caps
- DIN wheel (new design)



## S620Ti TITANIUM



X11.620.000

- Air balanced flow valve
- Diver-adjustable venturi-initiated vacuum assist (VIVA)
- Diver-adjustable inhalation effort
- Full metal valve housing
- Super-flow hose
- High comfort orthodontic mouthpiece

## S560



X11.560.000

- Lightweight techno-polymer barrel
- Air balanced flow valve
- Diver adjustable inhalation effort
- Diver-adjustable venturi-initiated vacuum assist (VIVA)
- High flow exhaust valve
- Super flow hose & ultra comfortable orthodontic mouthpiece

## G260



X11.263.000

- Air balanced flow valve
- Diver-adjustable inhalation effort
- Diver-adjustable venturi-initiated vacuum assist (VIVA)
- High flow exhaust valve
- Ultra comfortable orthodontic mouth piece
- Full metal valve housing

## C370



X11.370.000

- Compact body & exhaust tee
- Optimal flow design incorporates a special barrel & balanced poppet valve to produce maximum airflow under any diving conditions
- Diver-adjustable inhalation effort
- Venturi-Initiated Vacuum Assist (VIVA)
- Ultra-comfortable orthodontic mouthpiece

## R195



X11.331.000

- Classic downstream valve
- Diver-adjustable venturi-initiated vacuum assist (VIVA)
- Reversible hose attachment
- Super-flow hose
- Super comfort orthodontic mouthpiece
- Metal valve housing

## R095



X11.330.500

- Classic downstream valve
- Preset VIVA tuned for safe, uncomplicated use
- Super-flow hose
- High comfort orthodontic mouthpiece
- Full metal valve housing
- Reversible hose attachment

## R195 OCTOPUS



X11.331.200

- Classic downstream valve
- Diver-adjustable venturi-initiated vacuum assist (VIVA)
- Super-flow hose
- High comfort orthodontic mouthpiece
- Full metal valve housing
- Reversible hose attachment
- 1m yellow super flow hose

## R095 OCTOPUS



X11.330.400

- Classic downstream valve
- Preset VIVA
- High comfort orthodontic mouthpiece
- Full metal valve housing
- Reversible hose attachment
- 1m yellow super flow hose

## AIR 2 BLACK 5th GENERATION



X21.090.000

- Downstream valve
- Air-balanced power inflator valve
- Pre-tuned fixed VIVA flow vane
- Improved design, control & safety for BC inflating
- Larger deflation button & high comfort mouthpiece



## DIVE CENTRE PACKAGE

SCUBAPRO

BEST SELLER



XRS2

### "DEEP DOWN YOU WANT THE BEST" Now you can have the best at a price you can afford

A combination of the bulletproof Scubapro MK2 Evo regulator set & the outstanding T-One BCD. The MK2 has an unrivaled reputation within the dive industry for unhindered and continued use, a reputation improved further with this latest Evo model: Reduced size & weight, yet increased performance (air flow increased by 15% > 3,000 L/min) . The practical T-One BCD sets a new standard in looks and longevity.

#### The SCUBAPRO set includes:

##### T-One BCD - 5th Generation

- Heavy duty 'colour lock' cordura 1000 denier exterior
- Comfortable nylon 420 denier interior
- Carbon reinforced shoulders
- Balanced power inflator
- Internal octopus/console holder
- Padded cummerbund & backpack
- Color coded size tabs

T-One Size	XXS	XS	S	M	L	XL	XXL
Colour Coded	Pu	Pi	G	B	Li	O	Gp
Lift Capacity in Kg.	9	11	14	17	18	21	22

##### R095/R095 Octopus

- Classic downstream valve
- Full metal valve housing
- Preset VIVA
- Left or Right hose configuration
- Superflow hose
- High comfort orthodontic mouthpiece

##### MK2 EVO 1st Stage

- Industry renowned 'workhorse' regulator
- Standard piston design
- New XTIS (extended thermal insulating system)
- 15% increase in flow rate (>3,000LPM)
- 4 LP ports & 1 HP port

##### Console 2

- Genuine SCUBAPRO hose & gauges
- Pressure gauge 300bar
- Depth gauge 60m with parabolic scale & maximum depth indicator
- Lightweight & compact
- Loop on case to attach a safety lanyard
- Fluorescent dials

## HYDROS X BCD

SCUBAPRO

NEW



- HYDROS X is based on the same modular Monprene® harness and backpack design popularized by the Hydros Pro back-inflation BCD
- NEW EndurTex high-tenacity 420 nylon fabric bladder is lightweight yet extremely durable
- Monprene® thermoplastic harness is extremely resistant to UV, chemicals and abrasion, plus it doesn't absorb water to minimize drying time
- Rotating quick-release shoulder buckles allow you to route your shoulder straps to optimize fit
- Super Cinch tank buckle system locks the tank in solid for maximum stability at depth
- Integrated front weight system is based on the same Monprene® pockets found on the HYDROS PRO
- Two big zippered cargo pockets offer great gear-carrying capacity and are easily accessible even when the weight pouches are fully loaded
- Two stainless steel D-rings provide clip-on points for additional gear
- Includes Multi-Mount Accessory Matrix with multiple D-rings and mounting points that easily attach various dive accessories
- Color kits available pg 65
- Buoyant lift ranges from 13kg to 20kg for men, and 13kg to 17kg for women, depending on size

#### Men:

S...X21.900.200  
M...X21.900.300  
L...X21.900.400  
XL-2XL...X21.900.500

#### Women:

XS-S...X21.901.100  
M...X21.901.300  
L...X21.901.400



# HYDROS PRO BCD



Hydros Pro Man... X21.730  
Hydros Pro Lady... X21.736



- Winner 'BEST IN SHOW' - DEMA 2015
- Innovative high tech modular system
- Monprene ® TPE (thermoplastic elastomer)
  - Unrivalled strength & durability
  - Water resistant
  - Super quick drying
- Integrated weights system, 3 dump valves, 6 D-rings with adjustable height, trim pockets
- Colours for Men: Black, Blue, Orange, White, Yellow
- Colours for Women: Pink, Purple, Black, White
- Converts into a lightweight travel BCD with free backpack
- Sizes for Men: S, M, L, XL-XXL
- Sizes for Women: XS-S, M, L

Introducing the key to transforming your dive experience. Hydros Pro is an incredible feat of engineering offering unprecedented convenience, on-the-go configuration & specialized fits. Hydros Pro isn't just for professionals, it's for anyone who loves to dive & wants the best

### Instant Dry & Durable

No water absorption means neutral buoyancy & a light weight BC that is dry when it comes out of the water. Hydros Pro also stands up to UV, chemicals & abrasion

### Smart-Pack Design

Pack your entire kit into the small backpack (included) & get going

### 2-in-1 BC

With a quick switch of clips, Hydros Pro transforms from a basic harness travel BC to a jacket with fully integrated weight pockets

# HYDROS PRO BCD ACCESSORIES

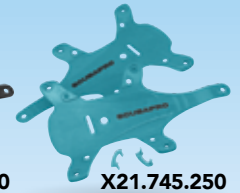

- Colour Kit Army Green...X21.745.010
- Colour Kit Black...X21.745.100
- Colour Kit Blue...X21.745.200
- Colour Kit Turquoise...X21.745.250
- Colour Kit Orange...X21.745.400
- Colour Kit Yellow...X21.745.500
- Colour Kit White...X21.745.600
- Colour Kit Pink...X21.745.700
- Colour Kit Purple...X21.745.710
- Mini D-ring Set...X21.746.002
- Ninja Pocket...X21.746.005
- Cargo Thigh Pocket...X21.746.006
- Accessory Bungee Set - M...X21.746.400
- Accessory Bungee Set - L...X21.746.500

## T-ONE BCD



- Heavy duty Cordura 1000D exterior & lightweight 420D interior
- Adjustable chest strap
- Comfort backpack
- 2 Pockets with restyled graphics & internal octopus holder
- Adjustable padded cummerbund
- Available in 7 sizes
- Balanced power inflator

2XS...X21703XXS  
XS...X21703XS  
S...X21703S  
M...X21703M  
L...X21703L  
XL...X21703XL  
2XL...X21703XXL

## EQUATOR BCD



- New easy-to fold small back pack for lightweight travel
- Super cinch tank band with redesigned double tank straps
- Integrated weight pockets with low-profile buckles
- High quality anti-scratch patches on sides & shoulders
- 6 Stainless steel D-Rings
- Knife grommets
- 2 Zipper pockets
- Rotating shoulder buckles
- Low profile dump valves
- Balanced power inflator
- Soft neck finishing
- 420D nylon material
- Octopus pockets on both sides

XS...X21.725.100  
XL...X21.725.500

## SEAHAWK 2 BCD



- Ergonomic shoulder design with rotating buckles improves fit
- Reinforced soft backpack with high-grip tank patch and inner padding
- Super Cinch stainless steel tank band system
- 50mm waist strap with lightweight plastic buckle
- Two large zippered pockets providing lots of cargo-carrying capability
- 6 Stainless Steel D-Rings
- Constructed of 1000 denier nylon and 420 denier nylon for maximum durability
- Air cell offers substantial buoyant lift when inflated.
- Balanced power inflator
- Soft neoprene neck roll and padded back pad.
- Quick-release integrated weight pouches secured with low-profile buckles
- Two rear trim pouches help create a comfortable swimming position

2XS...X22.142.010-2XS  
XS...X22.142.110-XS  
S...X22.142.210-S  
M...X22.142.310-M  
L...X22.142.410-L

## CHILD BCD



UBC3S

- 1000 Denier Cordura
- Velcro pocket & zippered pocket
- Adjustable cummerbund waistband
- Quick release shoulder straps
- Sub-Alert Power Inflator
- Soft Backpack Pad
- 3 dump valves
- Plastic tank cam lock buckle

## GLIDE BCD



### Grey:

XS...X22.285.120-XS  
S...X22.285.220-S  
M...X22.285.320-M  
L...X22.285.420-L  
XL...X22.285.520-XL

- Constructed of 420 denier nylon for lightweight & long-lasting durability
- Two large zippered pockets w. knife grommets
- 4 Angled stainless steel D-rings along with two smaller stainless D-rings
- Wrap around air bladder
- New Y-Fit shoulders to maximize fit & comfort
- Soft neoprene neck & padded backpack
- Super cinch tank buckle system
- Adjustable cummerbund
- Quick-release integrated weight pouches
- Counter balance trim pockets



SCUBAPRO



## SIDEMOUNT



X21.726.200



X21.726.400



X21.726.001

- Modular approach
- Compact independent aircell
- Two aircell sizes: 12 / 20 liters lift (25 / 45lbs.)
- Soft Airnet finished backpack
- Compatible with X-TEK steel & aluminum back plates
- Stainless steel grommets, D-rings & handles
- New Dump valve, corrugated hose & BPI
- Specific streamlined elbow
- Bungee & hooks for tank support
- Fully adjustable, easy to wear & configure
- Harness includes crotch strap
- Side bungees for streamlined shape
- Optional top cover for total stream lining & increased durability

Wing 12L...X21.726.200

Wing 20L...X21.726.400

Harness Backpad System...X21.726.001

## X-TEK PURE SINGLE SYSTEM



X22.195.010

- Legendary PURE harness with stainless steel backplate
- Single tank adapter with two super cinch straps
- Stainless steel shoulder & waist D-rings
- 50cm wide crotch strap with two D-rings
- 1680 Denier ballistic nylon outer shell
- 420 Denier inner bladder
- Tek balanced inflator
- 13kg / 28lb donut wing

## PURE HARNESS



X22.179.000

- Stainless steel back plate with "tri-glide" fasteners
- Secure continuous webbing provides custom fit
- Stainless steel waist buckle
- Back plate storage pack to fit large SMB
- 2 Shoulder & 1 left D-ring on waist belt
- 50mm crotch strap with two stainless steel D-rings

## DONUT WING



18kg for Twins...X22.183.010



13kg for Singles...X22.193.010

- Provides unprecedented buoyancy control regardless of diving position
- 1680 Denier ballistic nylon outer shell
- 420 Denier nylon inner bladder
- Tek balanced power inflator
- 13kg or 18kg lift capacity

## FORM HARNESS



Complete Set...X22.182.000  
w/o Backplate, w/o crotch strap...X23.806.000

- Shoulder straps adjust in length & alignment
- 50mm crotch strap with 2 stainless steel D-rings
- 6 Large & 6 regular stainless steel D-rings
- Anatomically optimized back padding
- 3 Piece comfort-harness-system
- Stainless steel back plate

## TRIM WEIGHT POCKET KIT



X23.721.010

## BACKPLATE

SCUBAPRO

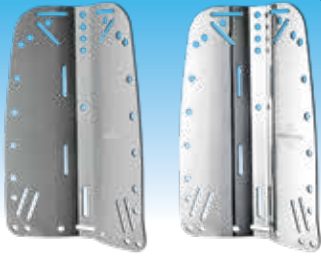

Stainless Steel...X23.800.000  
Aluminum...X23.801.000

Available in stainless steel or lightweight aluminum

## BACKPLATE STORAGE PACK

SCUBAPRO



X23.808.000

## WEIGHT POCKETS

SCUBAPRO



X23.803.000

• Weight pocket system w. quick release buckle & D-ring

## SOFT TRAVEL BACKPLATE

SCUBAPRO



X23.807.000

- Replaces metal backplate
- Includes 2 x super cinch tank straps
- Only compatible with FORM harness

## SHOULDER PADS

SCUBAPRO



X23.809.000

- Shoulder pads for ultimate comfort

## SINGLE TANK ADAPTER

SCUBAPRO



X23.802.000



# DEEP DOWN YOU WANT THE BEST

SCUBAPRO



## CONSOLE 3 SLIM



X05.011.753

- Compact pressure gauge (0-400bar) w. brass case
- Oil-filled analog depth gauge w. linear Bourdon tube design
- 35-degree tilt, oil-filled compass

## CONSOLE 2



X05.012.210

- Pressure gauge 300bar
- Depth gauge 60m with parabolic scale & maximum depth indicator
- Lightweight & compact
- Loop on case to attach a safety lanyard
- Fluorescent dials

## PRESSURE METAL GAUGE



X05.023.112

- Rated to 400bar
- Low Pressure 50bar red area for easy visibility
- Luminous dial for visibility, even in low-light
- Robust nylon protective housing
- 90cm HP Hose

## FS-2 COMPASS



X05.017.001



X05.017.111



X05.017.121

- Northern & Southern hemispheres compatible

FS-2 w. Mount for Retractor...X05.017.111

FS-2 w. Mount & Retractor...X05.017.121

FS-2 Capsule only...X05.017.001

Retractor for FS-1 / FS-2 Compass... X06.203.170

X06.203.170

## DIGITAL 330M



Wrist Mount...X05.014.110



Capsule only...X05.014.010

- Electronic data delivery system provides actual & maximum depth, ascent speed, dive time & temperature. Rated to 330m

## CB-TWO IN LINE



FSS005249220

- Depth gauge 70m
- Pressure gauge 300bar
- Modular housing

## CB-TWO IN LINE ZOOP NOVO



Lime...FSS022217000  
Black...FSS022218000

- Zoop Novo dive computer
- Pressure gauge 300bar
- Modular housing

## CB-ONE



FSS005240200

- Console housing & hose
- SM-36 pressure gauge 300bar

## BOOT & BUNGEE CORD



- for SK7 & SK8



FSS020627000



**SK-8** SUUNTO

Wrist Compass NH...FSS020981000  
Wrist Compass SH...FSS020982000

Bungee Mount NH...FSS021118000  
Bungee Mount SH...FSS021119000

- High tilt compensation
- Phosphorescent compass card

**CB-71 / SK-8** SUUNTO  
CONSOLE MOUNT

NH - Back...FSS021123000  
SH - Back...FSS021161000

NH - Front...FSS021122000  
SH - Front...FSS021160000

- High tilt compensation
- Phosphorescent compass card

**CLIPPER** SUUNTO  
COMPASS

FSS004102011

- Liquid filled compass
- Rotating bezel with 10 degree increments
- A fun, super-compact aid for underwater navigation
- Fits to almost any watch strap or wrist strap, sleeve, backpack strap, etc.

**CONSOLE 2** DEEPBLUE  
SLIMLINE

DBT30030

- Robust & compact console
- PG nickel plated brass, 0-300bar
- DG w. luminous display, 70m
- Easy to read
- HP hose included

**CONSOLE 2** DEEPBLUE  
MINI 2K

DBT30026

- Sleek & compact console
- Slimline PG 0-400bar
- DG w. luminous display, 70m
- Easy to read
- HP hose included

**HOUSING** DEEPBLUE  
CONSOLE MINI 2K

DBT30026E

**SPG** DEEPBLUE  
MINI 2K

DBT30013

- Sleek & compact
- Low profile boot
- Slimline PG 0-400bar

**SPG 2010 MINI 2K** DEEPBLUE

• Slimline pressure gauge with boot, 0-400bar  
• HP hose included

Yellow Dial w. Black Boot...DBT30038-K  
Yellow Dial w. White Boot...DBT30038-W  
Black dial w. Black Boot...DBT30038-KK

**CAPSULE** DEEPBLUE

DBT30009

DBT30001

Capsule for Pro Compass...DBT30001  
Capsule for Standard Compass...DBT30009

## STANDARD COMPASS



DBT30008

- Large tilt potential and still respond quickly and accurately
- High strength magnets for fast stabilization
- Bold numbers for ease of reading
- Firm-grip ratcheting bezel
- Luminescent compass card
- Oil filled
- Easy to read lubber line
- Top or side reading
- Diameter 60mm

## PRO COMPASS



DBT30002

- Exceptional tilt allows the compass to be held at an angle of up to 30degree and still respond quickly and accurately
- High strength magnets for fast, positive action
- Bold numbers for ease of reading
- Firm-grip ratcheting bezel
- Luminescent floating card
- Filled with liquid silicone
- Easy to read lubber line
- Top or side reading
- Diameter 56mm

## PRESSURE GAUGES CAPSULE



X28.163.002

X28.152.002

X28.163.202

X28.152.202

X05.022.012

X05.012.012

X28.039.302

DBT30012

DBT30039NS

FSS05108M200

SAP-0018

- PG capsule-Dia 63mm-Black Dial...X28.163.002
- PG capsule-Dia 52mm-Black Dial...X28.152.002
- PG capsule-Dia 63mm-White Dial...X28.163.202
- PG capsule-Dia 52mm-White Dial...X28.152.202
- Compact Press. Gauge...X28.039.302
- U-Line PG...X05.012.012
- U-Line Metal PG...X05.022.012
- SM-36/300 PG Module...FSS05108M200
- PG for Mini 2K - 48mm dia...DBT30012
- PG for Slimline - 52mm dia...DBT30039NS
- Miniature SPG (Pony Gauge) ...SAP-0018

## DEPTH GAUGES CAPSULE



X05.012.011

X28.860.005

DBT30007

DBT30040C

FSS05040M010

FSS05040M020

BS226001

- Compact Depth Gauge...X28.860.005
- U-Line DG...X05.012.011
- Depth Gauge for Slimline...DBT30040C
- Depth Gauge for Mini 2K...DBT30007
- Depth Gauge Module...BS226001
- SM-16/45 Depth Module...FSS05040M010
- SM-16/70 Depth Module...FSS05040M020

## COMPASS CAPSULE



- SK-8 Replacement Compass Capsule



- SK-8 Capsule NH...FSS021120000
- SK-8 Capsule SH...FSS021121000



## GALILEO G2

SCUBAPRO



X05.081.111  
50,955.-

Bluetooth®



X05.080.101



Intuitive, reliable & bulletproof, SCUBAPRO has combined everything you love about the Galileo with everything you've dreamed of in a dive computer. It's everything you expect from SCUBAPRO in full colour

Easy to read, Easy to use, Easy to love

Spend less time reading manuals & more time enjoying the experience

### Easy to manage

- Bluetooth compatible, the G2 easily syncs with your PC, Mac, Android or iOS
- Stores up to 1,000hrs of dive profiles
- Rechargeable battery lasts up to 50 dives

### Make it your own

- Customize your screen, colours, orientation & even the attachments to make the G2 truly your own
- Customized menu listings give you the ability to use as much or as little of the technology as you want; with easy activation of freediving, trimix, CCR & sidemount modes without downloading or upgrading
- The G2 is targeted to quickly become the favorite computer for all divers of all skill levels & goes wherever your passion for diving takes you
- Even your dive profile is one of a kind-based upon your real-time breathing rate, your skin temperature & your heart rate

Galileo G2 Wrist Only...X05.080.101  
Galileo G2 Console...X05.081.111

## ACTION / ACTION HR seac



White



HR - Black



Black

- Easy to use, with 3 main modes:
  1. SCUBA MODE: full management of recreational dive profiles with a Bühlmann ZHL-16C decompression algorithm for 1 or 2 mixes (air, Nitrox, & mixes with O2 concentrations up to 99%)
  2. GAUGE MODE: Depth gauge & stopwatch for managing your dive profiles independently.
  3. FREEDIVING MODE: Dive/surface time, current/maximum depth
- LOGBOOK MEMORY: SCUBA mode: 40 hours with records every 5". FREEDIVING mode: 18 hours of activity with records every 2"
- SAFETY WARNING: MOD exceeded alarm, deco stop violated alarm, ascent speed alarm, NoFly time & desaturation calculations, maximum permitted altitude warning
- "NDL only" Dive Planner
- Dive Manager software for MAC/PC (requires Windows 10)
- Download data via USB cable (optional accessory)
- Ultra-durable structure treated for improved resistance to blows, corrosion, & swings in temperature
- LCD screen with contrast & adjustable-intensity backlighting
- Long-lasting CR2450 battery
- Available in version with crown, buttons, & buckle in stainless steel (Action) or with HR treatment (Action HR)

Black...B16006-K  
Black...B16005-K  
Black/White...B16005-KW

## D6i NOVO & ZULU SUUNTO



Black Nylon



Blue Nylon



Black

- Steel case & sapphire crystal glass with anti-reflective coating
- Full continuous decompression algorithm - Suunto RGBM
- Gas-switching between up to three gases
- Five modes: air, nitrox, gauge, free & off
- Innovative apnea timer & timer in air/nitrox modes
- Integrated tilt-compensated 3D digital compass
- Updateable firmware
- Optional wireless air integration - current cylinder pressure, remaining air time
- Built-in dive planner
- Detailed graphical logs & dive data on your PC/Mac using PC/MAC with Suunto DM5 software & USB cable

Black...FSS021956000  
Black w. Nylon Strap...FSS022617000  
Blue w. Nylon Strap (for Instructor)...FSS022910000

## ACCESSORIES

Transmitter LED smart+

SCUBAPRO



X05.055.030



## DIVE COMPUTER SUUNTO ACCESSORIES



Boot & Bungee Cord



Tank Pod for Eon Core, Eon Steel, D5



Transmitter LED for DX, D9tx, D6i, D4i, Vytec, Vyper Air & HelO2

Tank Pod Transmitter...FSS020306000  
EON Steel Scratch Guard (1 Piece)...FSS021027000  
Tank Pod Battery Kit...FSS020308000  
Bungee Adapter EON Steel...FSS020309000  
Boot for EON Steel...FSS020310000  
EON Elastomer Strap Replacement Kit...FSS020311000  
SUUNTO Charger...FSS018799000  
Boot & Bungee Cord...FSS020628000  
Transmitter LED...FSS019098000



D5

SUUNTO

NEW SUUNTO D5 COPPER

NEW



Black/Lime



Black

All-Black

White



100m  
WATER  
RESISTANCE



WIRELESS TANK  
PRESSURE



VIBRATION  
ALARMS



DIGITAL  
COMPASS



USER EXCHANGEABLE  
STRAPS



RECHARGEABLE  
BATTERY



USER UPDATABLE  
SOFTWARE



WIRELESS MOBILE  
CONNECTION

# LET'S EXPLORE TOGETHER



- Easy to read (High contrast colour screen with large numbers)
- 3 modes: Air, nitrox, freedive and gauge
- Vibration alarms
- Rechargeable battery (10-20 hrs of dive time with one charge)
- Connect over Bluetooth to Suunto App
- Updatable software
- Integrated tilt-compensated 3D digital compass
- Wireless air integration (Optional)
- Suunto Fused™ RGBM2 for maximum dive time
- Reinforced composite case rated to 100 m depth
- User exchangeable straps (multiple optional straps available)

All-Black...FSS050192000  
 Black/Lime...FSS050191000  
 Black...FSS050190000  
 White...FSS050181000  
**NEW! Copper...FSS050569000**

D4i

SUUNTO



White

Black

Lime

- Soft silicone strap
- Metal buttons
- Full continuous decompression algorithm
- Three dive modes: air, nitrox, free
- Innovative apnea timer
- Optional wireless air integration (Transmitter)
- Detailed graphical logs on PC/MAC with Suunto DM5 software & USB cable
- Updateable firmware
- USB interface cable sold separately - Black, Lime & White

Black...FSS050277000  
 Lime...FSS050279000  
 White...FSS050278000

## D5 STRAPS DESIGNED FOR DIVING

SUUNTO



FSS050207000

FSS050206000

FSS050244000

FSS050243000

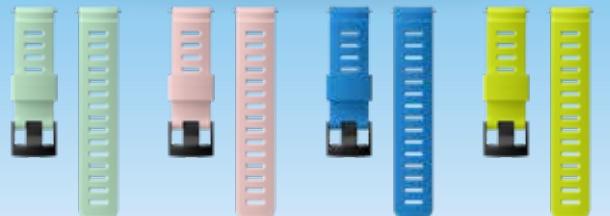

FSS050242000

FSS050241000

FSS050240000

FSS050208000



FSS050265000

FSS050264000

FSS050263000

FSS050229000



FSS050228000

- DIVE 1 Silicone Strap, Lime/Black, M...FSS050208000
- DIVE 1 Silicone Strap, Black/Steel, M...FSS050206000
- DIVE 1 Silicone Strap, White/Steel, M...FSS050207000
- DIVE 1 Silicone Strap, Blue/Black, M...FSS050240000
- DIVE 1 Silicone Strap, Sakura/Black, M...FSS050241000
- DIVE 1 Silicone Strap, Ocean/Black, M...FSS050242000
- DIVE 1 Silicone Strap, Coral/Black, M...FSS050243000
- DIVE 1 Silicone Strap, Amber/Black, M...FSS050244000
- EXPLORE 2 Textile Strap, Black/Black, M+L...FSS050228000
- EXPLORE 2 Textile Strap, Foliage/Grey, M+L...FSS050229000
- DIVE 2 Textile Zulu Strap, Stealth/Black, L...FSS050264000
- DIVE 2 Textile Zulu Strap, Black/Black, L...FSS050263000
- DIVE 2 Textile Zulu Strap, Blue/Black, L...FSS050265000

## D5 STRAPS

DESIGNED FOR EVERYDAY WEAR

SUUNTO

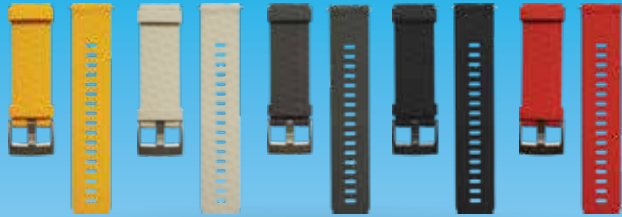

FSS050012000 FSS050223000 FSS050222000 FSS050221000 FSS050220000

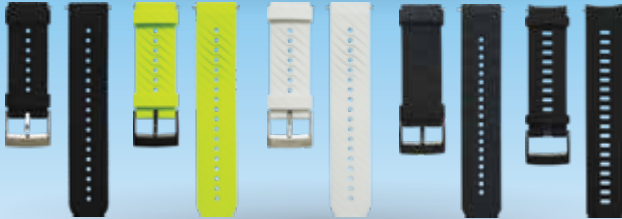

FSS050155000 FSS050157000 FSS050156000 FSS050158000 FSS050013000

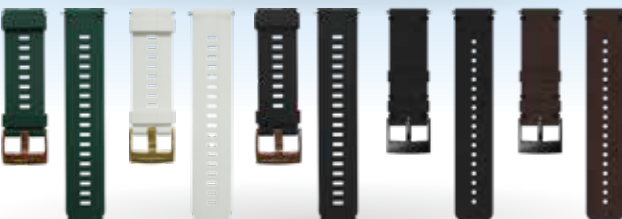

FSS023314000 FSS023485000 FSS023313000 FSS050231000 FSS050232000

EXPLORE 1 Silicone Strap, Amber/Gray, M...FSS050012000  
 EXPLORE 1 Silicone Strap, Coral/Gray, M...FSS050220000  
 EXPLORE 1 Silicone Strap, Black/Black, M...FSS050221000  
 EXPLORE 1 Silicone Strap, Graphite/Gray, M...FSS050222000  
 EXPLORE 1 Silicone Strap, Sandstone/Gray, M...FSS050223000  
 ATHLETIC 3 Silicone Strap, Black/Steel, M...FSS050155000  
 ATHLETIC 3 Silicone Strap, White/Steel, M...FSS050156000  
 ATHLETIC 3 Silicone Strap, Lime/Black, M...FSS050157000  
 EXPLORE 2 Silicone Strap, Black/Black, M...FSS050158000  
 EXPLORE 3 Silicone Strap, Stealth/Black, M...FSS050013000  
 ATHLETIC 4 Silicone Strap, Black/Copper, M...FSS023313000  
 ATHLETIC 4 Silicone Strap, Forest/Copper, M...FSS023314000  
 ATHLETIC 4 Silicone Strap, White/Gold, M...FSS023485000  
 URBAN 2 Leather Strap, Black/Black, M...FSS050231000  
 URBAN 2 Leather Strap, Brown/Black, M...FSS050232000

## VYPER NOVO

SUUNTO



White

Graphite

- Optional wireless air integration – current cylinder pressure, remaining air time
- Integrated tilt-compensated 3D digital compass
- Gas-switching between up to three gases (Oxygen up to 99%)
- Cable optional for connecting to detailed graphical logs & dive data with your PC/Mac using Suunto DM5 software
- Full continuous decompression algorithm – Suunto RGBM
- Five modes: air, nitrox, gauge, free & off
- Innovative apnea timer for free diving & a timer in air Nitrox modes
- Built-in dive planner

White...FSS050433000  
 Graphite...FSS050434000

## EON CORE

SUUNTO



Lime

White

Black

- User configurable Custom Display with up to 4 screens per mode
- Flip display option
- Wireless connectivity via Bluetooth
- Up to 10 tank pressure readings with Suunto Tank PODs
- User-updatable software
- Lightweight (154g) reinforced composite case rated to 80m (EON Steel = 347g)
- Modes: Air/Nitrox/Gauge/Trimix/CCR (fixed point)
- Suunto Fused™ RGBM2 decompression model
- Tilt compensated 3D digital compass
- Rechargeable lithium-ion battery 930 mAh (10-20hrs diving)
- PC/MAC with Suunto App & USB cable
- 17 languages

Black...FSS022740000  
 White...FSS023081000  
 Lime...FSS023082000

## ZOOP NOVO

SUUNTO



Lime

Black

Blue

- Five modes: air, nitrox, gauge, apnea & off
- Full continuous decompression algorithm - Suunto RGBM
- Built-in dive planner
- Detailed graphical logs & dive data with your PC/Mac using Suunto DM5 software (no cable in the package – sold as an accessory)
- Innovative apnea timer for freediving & timer in air/nitrox modes

Lime...FSS021643000  
 Blue...FSS021644000  
 Black...FSS021645000  
 Rental, Lime...FSS022692000



	D4i	D5	D6i Novo	ZOOP Novo	VYPER Novo	EON Core
<b>Glass material:</b>	Mineral crystal	Mineral crystal	Sapphire crystal	Acrylic	Acrylic	Mineral crystal
<b>Case material:</b>	Composite	Reinforced composite	Steel	Composite	Composite	Reinforced composite
<b>Strap material:</b>	Silicone	Silicone	Silicone / metal	Elastomer	Elastomer	Elastomer
<b>Water resistance</b>	100 m	100 m (ISO 6425, EN 13319)	150 m	120 m	120 m	80 m
<b>Battery life in time mode</b>	2 years	-	2 years	2 years	2 years	2 months
<b>Battery life 100 dives/year</b>	1.5 years	-	1.5 years	1.5 years	1.5 years	-
<b>Battery type</b>	CR 2450	rechargeable lithium-ion	CR 2450	CR 2450	CR 2450	rechargeable lithium-ion
<b>UI languages</b>	EN	EN, FR, ES, IT, NL, PT, SV, FI, RU, PL, KO, ZH, DE, NO, CS, DA, JA, ZH, TW	EN	EN	EN	EN, CS, DA, DE, ES, FI, FR, IT, JA, KO, NL, NO, PL, PT, RU, SV, ZH
<b>Backlight</b>	electro-luminescent	LED	electro-luminescent	electro-luminescent & phosphor-luminescent	electro-luminescent & phosphor-luminescent	LED
<b>Configurable backlight</b>	duration: off, 5, 10, 20, 30, 60 s	yes	duration: off, 5, 10, 20, 30, 60 s	duration: off, 5, 10, 20, 30, 60 s	duration: off, 5, 10, 20, 30, 60 s	yes
<b>Firmware upgradable</b>	yes	yes	yes	-	-	yes
<b>User replaceable battery</b>	-	-	-	yes	yes	-
<b>Digital compass</b>	-	yes	yes	-	yes	yes
<b>Tilt compensation</b>	-	up to 45°	up to 45°	-	up to 45°	up to 45°
<b>Maximum operating depth(EN 13319)</b>	100m	100 m / 328 ft (EN 13319, ISO 6425)	120m	80m	80m	80m
<b>Nitrox (and air)</b>	yes	yes	yes	yes	yes	yes
<b>Freedive</b>	yes	yes	yes	yes	yes	yes
<b>Gauge</b>	yes	yes	yes	yes	yes	yes
<b>Dive time</b>	0 to 999 min	0 to 999 min	0 to 999 min	0 to 999 min	0 to 999 min	0 to 999 min
<b>Wireless air integration</b>	optional	optional (up to 3 different tanks with Suunto Tank POD)	optional	-	optional	optional
<b>Decompression model</b>	RGBM	Suunto Fused™ RGBM 2	RGBM	RGBM	RGBM	FUSED RGBM
<b>Personal adjustment</b>	0 - 2	P+2, P+1, P0, P-1, P-2	0 - 2	0 - 2	0 - 2	from -2 to 2
<b>Altitude adjustment</b>	0-300m / 300-1500m /1500-3000m	0-300m / 300-1500m /1500-3000m	0-300m / 300-1500m /1500-3000m	0-300m / 300-1500m /1500-3000m	0-300m / 300-1500m /1500-3000m	0-300m / 300-1500m /1500-3000m
<b>Gases</b>	1 gas (O2 21 - 50%)	up to 3 gases (Oxygen 21 - 99%)	up to 3 gases (O2 21 - 99%)	1 gas (O2 21 - 50%)	up to 3 gases (O2 21 - 99%)	up to 10 gases (O2 5 - 99% / Helium 0 - 95%)
<b>Gas max pO2</b>	1.2 - 1.6	1.6	1.2 - 1.6	1.2 - 1.6	1.2 - 1.6	manual 0.5-1.6/ fixed 1.6
<b>Timer</b>	yes	yes	yes	yes	yes	yes
<b>No-decompression planner</b>	yes	yes	yes	yes	yes	yes
<b>Logbook memory</b>	~140 h (20s sampling rate)	200h or 400 dives which comes first	~140 h (20s sampling rate)	~140 h (20 s sampling rate)	~140 h (20 s sampling rate)	200 h
<b>Gas switching</b>	-	yes	yes	-	yes	yes
<b>Trimix (mixed gas)</b>	-	-	-	-	-	yes
<b>Rebreather (CCR)</b>	-	-	-	-	-	yes
<b>Custom displays</b>	-	4 per dive mode	-	-	-	4 per dive mode
<b>Dive time</b>	yes	yes	yes	yes	yes	yes
<b>Maximum depth</b>	yes	yes	yes	yes	yes	yes
<b>Tank pressure</b>	yes	yes	yes	-	yes	yes
<b>Apnea timer (O2/CO2 tables)</b>	yes	-	yes	yes	yes	-
<b>Diluents</b>	-	-	-	-	-	up to 10 diluents (O2 5 - 99% / Helium 0 - 95%)



## BORA PLUS MASK



Clear Skirt

BT Y K



**BEST SELLER**



Black Skirt

K Y O

- Silicone skirt & strap
- Easily replaced twist-on buckles
- Twin lens with tempered glass

Clear Skirt:

Black...DBMA36+-K  
Blue Trans...DB1MA36+-BT  
Yellow...DB1MA36+-Y

Black Skirt:

Black...DB1MA36+-KK  
Orange...DB1MA36+-O  
Yellow...DB1MA36+-KY

## XTREME MASK



Clear Skirt

B Pi



Black Skirt

W Y

- Silicone skirt & strap
- Swivel Buckles
- Twin lens w. tempered glass

Clear Skirt:

Blue...DBM282-B  
Pink...DBM282-Pi

Black Skirt:

White...DBM282-KW  
Yellow...DBM282-KY

## BALI MASK



DBMA69-KK

- Single lens w. tempered glass
- Silicone skirt & strap
- Swivel buckles
- Extra low volume

## HAWAII MASK



Clear Skirt

BT Y

- Replaceable standard buckles
- Twin lens w. tempered glass
- PVC skirt & strap

Clear Skirt:

Blue Trans...DB3MD05P-BT  
Yellow...DB3MD05P-Y

## ORCA MASK



Black Skirt

Y

Clear Skirt

B Pi

- Silicone skirt & Unique Elastomer strap
- Replaceable skirt-mounted buckles
- Twin lens w. tempered glass
- Low volume

**SUPER COMFORTABLE**

Black Skirt:

Yellow...DBMD89-KY

Clear Skirt:

Blue...DBMD89-B  
Pink...DBMD89-Pi

## FIJI FOR KIDS



Silicone Skirt

BT PIT Y



Blue Trans...DB8MB52-BT  
Pink Trans...DB8MB52-PIT  
Yellow...DB8MB52-Y

PVC Skirt

BT PIT Y



Blue Trans...DB4MB52P-BT  
Pink Trans...DB4MB52P-PIT  
Yellow...DB4MB52P-Y

Silicone Skirt w. Clamshell

BT PIT Y



Blue Trans...DB8MB52CL-BT  
Pink Trans...DB8MB52CL-PIT  
Yellow...DB8MB52CL-Y

- Silicone or PVC skirt & strap
- Replaceable clip-on buckles
- Single lens w. tempered glass
- Ideal for rental & retail

## MAKO MASK



Clear Skirt

BT Y



Black Skirt

K

- Silicone skirt & strap
- Easily replaced clip-on buckles
- Twin lens with tempered glass

Clear Skirt:

Blue Trans...DBMC23-BT  
Yellow...DBMC23-Y

Black Skirt:

Black...DBMC23-KK

## COVERT MASK



Black Skirt

B K Pi W

- Silicone skirt & strap
- Swivel buckles
- Twin lens w. tempered glass
- Extra low volume

Black Skirt:

Black...DBMC24-KK  
Blue...DBMC24-KB  
Pink...DBMC24-KPi  
White...DBMC24-KW

## VYPER MASK



DBMD56-KK

- Silicone skirt & strap
- Replaceable clip-on buckles
- Single lens w. tempered glass
- Extra low volume

## CORAL MASK



DBMCORAL

- Single lens w. tempered glass
- Silicone skirt & strap (Clear)
- Standard buckles, easy to adjust
- Available in Turquoise w. colourful coral motive

## ACCENT MASK



DBMG01-KY

- Single lens w. tempered glass
- Ultra Soft Silicone skirt (Black matte)
- Silicone strap (Black)
- Standard buckles, easy to adjust
- Available in Black/Yellow w. Black Skirt

## MAUI MASK



Blue...DBME60-B  
Pink...DBME60-Pi  
Yellow...DBME60-Y

**B Pi Y**

- Swivel buckles
- Extra low volume
- Silicone skirt & strap
- Single lens w. tempered glass
- Available in blue, pink & yellow

## D MASK

**NEW**



X24.252.101 X24.252.102 X24.252.103

X24.252.104 X24.252.105 X24.255.xxx

**K K B Tq Pi Y**

- Sleek design matches the new D420 regulator
- UV+420cut™ lens technology filters out HEV and UV light without affecting how colors appear
- Interchangeable lens system makes it easy to install optional optical lenses
- Available with a choice of skirts to suit western or Asian dive markets as well as divers with small face shapes
- Rotating buckles work with a new black-on-black Comfort Strap to optimize range of motion and achieve a comfortable, watertight fit
- Includes an adapter for mounting a HUD hands-free dive computer
- Packaged in a durable molded fabric transport box.
- Optional lenses available: Optical lenses (6x positive +1.5 to +4.0/8x negative -1.5 to -5.0); Bi-Focus lenses (3x positive +1.0 to +3.0)

D Mask, Black Asian ...X24.250.300  
Color Kit, Black...X24.252.101  
Color Kit, Blue...X24.252.102  
Color Kit, Turquoise...X24.252.103  
Color Kit, Pink...X24.252.104  
Color Kit, Yellow...X24.252.105

Bifocus Lens fit Left, D-Masks, +1.0 to +3.0...X24.255.0xx  
Bifocus Lens fit Right, D-Masks, +1.0 to +3.0...X24.255.1xx

## FULL FACE SNORKELLING MASK

Size S, Blue...DBFface-S-B  
Size S, Pink...DBFface-S-Pi  
Size L, Blue...DBFface-L-B  
Size L, Pink...DBFface-L-Pi

**B Pi**



- EASY BREATHING - Natural breathing through the nose or mouth
- EASY DRESSING - Adjustable elastic textile strap
- ANTI-FOGGING - An exclusive air circulation concept, that prevents the formation of fog
- WATERPROOF - The "Dry Top" snorkel system limits water entry through the top of the snorkel
- FIELD OF VISION - Panoramic field of vision
- WATER DRAINAGE - Purge valve at the bottom of the mask, to drain water when the head is raised
- Action camera mount
- Sizes: S, L

## SPECTRA METALLIC MASK

Black Skirt  
**B Br K Si**

Black Skirt w. Mirror Lens  
**K Br**

Clear Skirt  
**B**



- Silicone skirt & strap
- Swivel buckles
- Twin lens w. tempered glass
- Re-usable mask box included

**Black Skirt:**  
Full Black...X24.847.100  
Black/Silver...X24.847.130  
Solid Blue...X24.847.230  
Bronze...X24.847.830

**Black Skirt w. Mirror Lens:**  
Black...X24.847.140  
Bronze...X24.847.840

**Clear Skirt:**  
Blue...X24.847.210

## SYNERGY TWIN TRUFIT MASK

**Tq R Y**



Black Skirt

Black Skirt w. Mirror Lens



**K**

- Tru-fit silicone skirt (extra soft & super comfortable)
- Silicone mask strap
- Replaceable clip-on buckles
- Twin lens with tempered glass
- Low volume & provides excellent field of view
- Re-usable mask box included

**Black Skirt:**  
Turquoise...X24.713.230  
Red...X24.713.310  
Yellow...X24.713.510  
Solid Pink...X24.713.730

**Black Skirt w. Mirror Lens:**  
Black...X24.713.140

## SYNERGY TWIN TRUFIT MASK w. COMFORT STRAP

**Black Skirt:**  
Silver...X24.813.130  
Red...X24.813.310  
Yellow...X24.813.510  
Solid Pink...X24.813.730  
Turquoise...X24.813.230

**Si Tq R Y**

**Black Skirt w. Mirror Lens:**  
Silver...X24.813.140

**Si**



Black Skirt

Black Skirt w. Mirror Lens

- Tru-fit silicone skirt (extra soft & super comfortable)
- Comfort strap
- Replaceable clip-on buckles
- Twin lens with tempered glass
- Low volume & provides excellent field of view
- Re-usable mask box included

## STEEL COM MASK



**K W**

POPULAR FOR APNEA

- Silicone skirt & strap (ultra soft)
- Unique collapsible frame
- Swivel buckles
- Nose pocket w. anti-slip
- Twin lens w. tempered glass
- Extra low volume
- Ideal for APNEA

Black...X24.108.100  
White...X24.108.600

## SYNERGY 2 TRUFIT MASK w. COMFORT STRAP

**Black Skirt w. Mirror Lens:**  
Silver...X24.839.140

**Black Skirt:**  
Silver...X24.839.130



Black Skirt

Black Skirt w. Mirror Lens

**Si**

**Si**

- Tru-fit silicone skirt (extra soft & super comfortable)
- Comfort strap
- Swivel buckles
- Single lens with temper-glass
- Low volume & provides excellent field of view
- Re-usable mask box included

## TRINIDAD MASK



**K**

- Silicone skirt & strap
- Swivel buckles
- Single lens w. tempered glass
- Frameless, low-volume design
- Re-usable mask box included

**X24.156.100**

## CRYSTAL VU METALLIC MASK

**Black Skirt**

**O Si**

**Black Skirt:**  
Orange...X248551-KO  
Silver...X248551-KSi



Clear Skirt

**B Y W R**

**Clear Skirt:**  
Blue...X248551-B  
Red...X248551-R  
White...X248551-W  
Yellow...X248551-Y

- Silicone skirt & strap
- Swivel buckles
- Single lens with seamless side windows & tempered glass
- Re-usable mask box included

## SOLO MASK

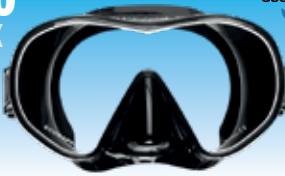

**K**

- Silicone skirt & strap
- Swivel buckles
- Single lens w. tempered glass
- Extra low volume
- Re-usable mask box included

**X24.849KS**

## ZOOM MASK



White Skirt



Black Skirt



X24.157.101

X24.157.102

X24.157.103

X24.157.104

X24.157.105

X24.157.106

X24.157.107

X24.157.108

X24.157.109

**X24.595.4XX**

**Black Skirt:**  
Black/Silver...X24.157.001  
Blue/Silver...X24.157.002  
Yellow/Black...X24.157.005  
Red/Black...X24.157.006  
Pink/Black...X24.157.007

**White Skirt:**  
White/Silver...X24.157.011

**Lens Left or Right:**  
Prescription Lens -1.0 to -8.0...X24.595.4xx

**BIFOCUS LENS:**  
Left side only, +1.00...X24.595.200  
Left side only, +2.00...X24.595.203  
Left side only, +3.00...X24.595.204  
Right side only, +1.00...X24.595.300  
Right side only, +2.00...X24.595.303  
Right side only, +3.00...X24.595.304



**X24.595.XXX**

**BIFOCUS LENS FINO/ZOOM Masks**

**Color Kit:**  
Black/Silver...X24.157.101  
Blue/Silver...X24.157.102  
Yellow/Silver...X24.157.103  
Silver...X24.157.104  
Yellow/Black...X24.157.105  
Red/Black...X24.157.106  
Pink/Black...X24.157.107  
Turquoise/Black...X24.157.108  
Purple/Black...X24.157.109

- Quick lens change system
- Twin ultra clear no tint glass lenses
- Low volume design
- Easy adjust quick release buckles

## FRAMELESS MASK



**K**

- Large, teardrop-shaped Ultra Clear lenses
- Soft silicone skirt uses a double-seal system
- Traditional buckles attach to the skirt
- Wide headband allows for a comfortable fit

**X24.350.110**

## GHOST MASK



**K W**

Black...X24.110.101-K  
White...X24.110.001 -W



- Super soft silicone skirt
- Single ultra clear no tint glass lens
- EZ Open Mask Strap
- Flexible, easy adjust buckles



## MARINA KIDS MASK

SEAC



**B Y Pi**

Blue...B9426-B  
Pink...B9426-P  
Yellow...B9426-Y

- Silicone skirt & strap
- Replaceable standard buckles
- Single lens w. tempered glass
- Packaging: plastic mask box

## RUNNER MASK

BEST SELLER



Clear Skirt

**BT C K Y**

Black Skirt

**BT G Y K**

ALL TIME FAVORITE



Clear Skirt:

Blue Trans...S1083S-BT  
Clear...S1083S-C  
Black...S1083S-K  
Yellow...S1083S-Y

Black Skirt:

Blue Trans...S1083KS-BT  
Green...S1083KS-G  
Black...S1083KS-K  
Yellow...S1083KS-Y

- Silicone skirt & strap
- Replaceable standard buckles
- Twin lens w. tempered glass
- Optical Lenses available

## RUNNER JUNIOR MASK



**BT Y FG**

Blue Trans...SMS102-BT  
Neon Green...SMS102-FG  
Yellow...SMS102-Y

- Silicone skirt & strap
- Replaceable twist-on buckles
- Single lens w. tempered glass

## OPTICAL LENSES



S1083OP



Distance (-)  
(Myopia)

Close (+)  
(Presbyopia)

S1083P6

Myopia Lens:

Lens -1.0...S1083OP-1.0  
Lens -1.5...S1083OP-1.5  
Lens -2.0...S1083OP-2.0  
Lens -2.5...S1083OP-2.5  
Lens -3.0...S1083OP-3.0  
Lens -3.5...S1083OP-3.5  
Lens -4.0...S1083OP-4.0  
Lens -4.5...S1083OP-4.5  
Lens -5.0...S1083OP-5.0  
Lens -5.5...S1083OP-5.5  
Lens -6.0...S1083OP-6.0  
Lens -6.5...S1083OP-6.5  
Lens -7.0...S1083OP-7.0  
Lens -8.0...S1083OP-8.0  
Lens -9.0...S1083OP-9.0  
Lens -10.0...S1083OP-10.0

Bi-Focal Lens:

Lens -2/+1 Left...S1083P6L-2/1L  
Lens -2/+2 Left...S1083P6L-2/2L  
Lens -3/+1 Left...S1083P6L-3/1L  
Lens -2/+1 Right...S1083P6L-2/1R  
Lens -2/+2 Right...S1083P6L-2/2R  
Lens -3/+1 Right...S1083P6L-3/1R

Myopia Lens (Nearsighted) :

- Available from -1.0 through -7.0 in 0.5 increments
- Available from -7.0 through -10.0 in 1.0 increments

Bi-Focal Presbyopia Lens :

Myopia Lens	Presbyopia Lens		
-1.0	+1.0	+2.0	+3.0
-2.0	+1.0	+2.0	-
-3.0	+1.0	-	-

## FRAMELESS MASK



**K**

- Silicone skirt & strap
- Replaceable standard buckles
- Extra low volume
- Ideal for APNEA
- Single lens w. tempered glass

SMM107KS

## WIDE VISION MASK LARGE FIT-BLACK



**K**

- Silicone skirt & strap
- Replaceable standard buckles
- Single lens w. tempered glass
- High volume, wide vision

SMM108KS-K

## STEALTH MASK



**K**

- Silicone skirt
- 'Easy-adjust' buckles
- Twin lens
- Curved lenses (180-Degree field of vision)
- Extreme Low volume

SM205KS-K

## EXTREME MASK FOR SMALL FACES

SEAC



Black Skirt:  
Black...B936KS-K

**K**



Clear Skirt:  
Blue...B939-B  
Yellow...B939-Y

**B YT**

- Silicone skirt & strap
- Easy adjustable buckles
- Twin lens w. tempered glass
- Re-usable mask box included

## PRO EAR 2000 MASK

PROEAR2000



**K**

- Silicone skirt & strap
- Replaceable standard buckles
- Twin lens w. tempered glass
- Complete ear protection

MPE10

## DIVE OPTX Flexible Mask Magnifier Kit



TFM98 +1.0  
TFM98 +1.5  
TFM98 +2.0  
TFM98 +2.5  
TFM98 +3.0

- Available from +1.0 through +3.0 diopter in 0.5 increments

## CAPRI MASK

SEAC



**K**

Black Skirt:  
Black...B9421KS-K

Clear Skirt:  
Blue...B9420-B  
Black...B9420-K

- Silicone skirt & strap
- Replaceable standard buckles
- Twin lens w. tempered glass
- Packaging: plastic mask box

## MANTA PLUS SNORKEL



**BEST SELLER**

### Clear Mouthpiece:

Blue Trans...DB1SA106-BT  
Yellow...DB1SA106-Y

**BT Y**

### Black Mouthpiece:

Black...DB1SA106-K  
Orange...DB1SA106-O

**K O**



- Comfortable silicone mouthpiece
- Purge valve for effortless clearing
- Semi-dry top design prevents water entry into tube
- Standard universal snorkel keeper
- PVC Flex tube

## MARLIN SNORKEL



**BEST SELLER**

### Clear Mouthpiece:

Blue Trans...DBSA91-BT  
Clear...DBSA91-C  
Black...DBSA91-K  
Yellow...DBSA91-Y

**C BT Y K**

### Black Mouthpiece:

Black...DBSA91-KSK  
Yellow...DBSA91-KSY

**K Y**



- Comfortable silicone mouthpiece
- Silicone snorkel holder
- Simple J-Tube

## STINGRAY SNORKEL



**BEST SELLER**

### Clear Mouthpiece:

Blue Trans...DBSA105-BT  
Black...DBSA105-K  
Yellow...DBSA105-Y

**BT Y K**

### Black Mouthpiece:

Black...DBSA105-KK

**K**



- Ergonomic silicone mouthpiece for added comfort
- Purge valve at lowest point for effortless clearing
- Semi-dry top design prevents water entry into tube
- Standard universal snorkel keeper
- Flexible, corrugated joint drops snorkel from face when not in use

## SHARKY SNORKEL



### Clear Mouthpiece:

Blue Trans...DBSB47-BT  
Clear...DBSB47-C  
Black...DBSB47-K  
Yellow...DBSB47-Y

**C BT Y K**



- Ergonomic silicone mouthpiece for added comfort
- Purge valve at lowest point for effortless clearing
- Semi-dry top design prevents water entry into tube
- Standard universal snorkel keeper
- Flexible, corrugated joint drops snorkel from face when not in use

## BALI SNORKEL



Diva Pink...DBSD95-PD  
Yellow Mango...DBSD95-YM

**PD YM**



- Ergonomic silicone mouthpiece for added comfort
- Purge valve at lowest point for effortless clearing
- Semi-dry top design prevents water entry into tube
- Standard universal snorkel keeper
- Flexible, corrugated joint drops snorkel from face when not in use

## CORAL SNORKEL



DBSCORAL

- Comfortable silicone mouthpiece (for kids)
- Purge valve at lowest point for effortless clearing
- Semi-dry top design prevents water entry into tube
- Standard universal snorkel keeper
- Simple J-Tube (for kids)
- Available in Turquoise w. colourful coral motive

## MAKO SNORKEL



### Clear Mouthpiece:

Blue Trans...DB3SB35-BT  
Yellow...DB3SB35-Y

**BT Y**

### Black Mouthpiece:

Black...DB3SB35-KK

**K**



- PVC mouthpiece
- Purge valve at lowest point for effortless clearing
- Semi-dry top design prevents water entry into tube
- Unique strap holder built into the tube
- Simple J-Tube

## GOBY SNORKEL



### Clear Mouthpiece:

Blue Trans...DBSB36-BT  
Green Trans...DBSB36-GT  
Pink Trans...DBSB36-PIT  
Yellow...DBSB36-Y

**BT Y PIT GT**



- PVC mouthpiece for kids
- Semi-dry top design prevents water entry into tube
- Unique strap holder built into the tube
- Simple J-Tube

## DAMSEL SNORKEL



### Clear Mouthpiece:

Blue Trans...DB8SA102-BT  
Pink Trans...DB8SA102-PIT  
Yellow...DB8SA102-Y

**BT Y PIT**



- Comfortable silicone mouthpiece
- Purge valve at lowest point for effortless clearing
- Semi-dry top design prevents water entry into tube
- Standard universal snorkel keeper
- Simple J-Tube

## COVERT SNORKEL



DBSE13-KK  
**K**



- 100% Silicone Snorkel
- Foldable - always bounces back into shape
- Silicone mouthpiece
- Silicone snorkel holder

## ORCA SNORKEL



Clear Mouthpiece:  
Blue...DBSE42-B  
Pink...DBSE42-Pi

**B Pi**

Black Mouthpiece:  
Yellow...DBSE42-KY

**Y**

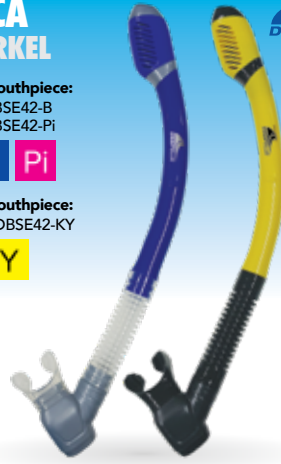

- Sealed dry top (100% dry)
- Purge valve at lowest point for effortless clearing
- Soft silicone flex
- Comfortable silicone mouthpiece

## XTREME SNORKEL



Clear Mouthpiece:  
Blue...DBSN134-B  
Pink...DBSN134-Pi

**B Pi**

Black Mouthpiece:  
White...DBSN134-KW  
Yellow...DBSN134-KY

**Y W**



- Sealed dry top (100% dry)
- Purge valve at lowest point for effortless clearing
- Soft silicone flex
- Comfortable silicone mouthpiece
- Standard universal snorkel keeper

## SPECTRA SNORKEL



Clear Mouthpiece:  
Blue...X26.706.220  
Yellow...X26.704.500  
Pink...X26.704.710  
White...X26.706.600  
Pink...X26.706.720

Black Mouthpiece:  
Purple...X26.704.750  
Bronze...X26.706.830  
Silver...X26.706.130

DIVE PRO FAVORITE

**Br**  
**Si**

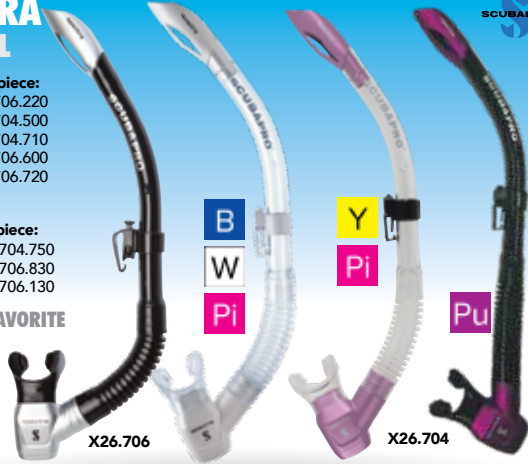

X26.706

X26.704



- Ergonomic regulator style mouthpiece for added comfort
- Purge valve at lowest point for effortless clearing
- Semi-dry top design helps prevent water entry into tube
- Quick-release clip for easy removal from mask strap
- Flexible, corrugated joint drops snorkel from face when not in use

## NEXUS SEMI DRY SNORKEL



Clear Mouthpiece:  
Blue...X26.810.220

**B**

Black Mouthpiece:  
Red...X26.810.320

**R**



- Ergonomic regulator style mouthpiece for added comfort
- Angled purge valve directs bubbles out of your sight line
- Splashguard top helps keep water from entering the large bore barrel
- Quick-connect clip makes it easy to attach or remove snorkel from mask strap
- Flexible upper barrel allows snorkel to be folded for storing
- Flexible, corrugated joint drops snorkel from face when not in use

## TRINIDAD SNORKEL



X26.070.000  
**K**

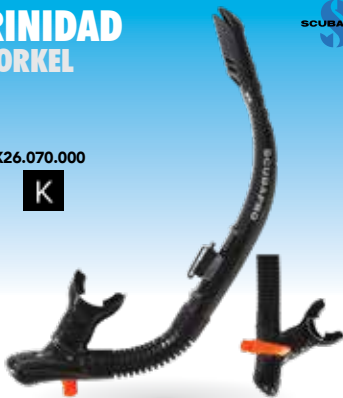

- Semi-dry top design prevents water entry into tube
- Flexible, corrugated joint drops snorkel from face when not in use
- Ergonomic, replaceable high grade silicone mouthpiece
- Purge valve for ease of clearing
- Adjustable snorkel keeper w.removable clip
- Integrated whistle for added safety (NEW)

## APNEA SNORKEL



Black...X26.130.000  
White...X26.130.600

**W K**



- Utilitarian - always bounces back into shape
- Silicone mouthpiece
- Lightweight
- Soft tube

## STANDARD SNORKEL



Black Mouthpiece:  
Black...S1052-K  
Yellow...S1052-Y

**Y K**



- Rubber mouthpiece
- PVC snorkel keeper
- Simple J-Tube



## VISION HD GOGGLES

SEAC



Blue...B9908-B  
Red...B9908-R

**B R**

- Oversized & durable frame reduces drag
- Comfortable leak-resistant hypoallergenic bio-silicone skirt
- Crystal clear wrap-around lens provides clear 180-degree visibility
- Anti-fog & scratch resistant lenses provide 100% UV protection
- Pulsar buckle system allows for quick strap adjustment with just a touch
- Protective storage pouch

## MARINER UV GOGGLES

SEAC



Blue...SK5UV-B  
Black...SK5UV-K

**B K**

- Anti-fog lens w. enhanced peripheral vision
- Soft silicone watertight seal
- Comfortable wrap-around lens provides high visibility
- Quick release buckle system & silicone strap
- Protective storage pouch included
- Anti-fog lens with enhanced peripheral vision & UV protection

## EAR PLUGS

SEAC



SE4

- Easy-to-use ear plugs
- Keep your ear canal perfectly dry during water activities
- Helps prevent ear infections
- Made from silicone

**Not suitable for SCUBA diving**

## WAVE GOGGLES

SEAC

Blue...S1281AS-B  
Blue Lagoon...S1281AS-BL  
Black...S1281AS-K

**BL**

**B**

**K**



- Comfortable silicone seal
- Lenses w. 100% UV protection & anti-fog coating
- Easy adjustable head strap
- Interchangeable nose bridge

## WAVE JUNIOR GOGGLES

SEAC

Blue...SS5-B  
Black...SS5-K  
Yellow...SS5-Y

**Y**

**B**

**K**



- Comfortable silicone seal
- Lenses w. 100% UV protection & anti-fog coating
- Easy adjustable head strap
- Interchangeable nose bridge

## NOSE CLIP

SEAC



SN2

- Ideal for swimmers & other water sports
- Comfortable nose clip
- Flexible steel frame with latex pads
- Comfortably pinch the nostrils shut
- Designed to pinch the nose to keep water out
- Weight: 50 grams (including packaging)



## BORA MASK & SNORKEL SET w. SPEED3 FINS



**Y**  
**B**  
**K**  
**O**

S-M, Blue...DB1SP3-SM-B  
S-M, Black...DB1SP3-SM-K  
S-M, Black/Yellow...DB1SP3-SM-KY  
S-M, Orange...DB1SP3-SM-O  
S-M, Yellow...DB1SP3-SM-Y  
L-XL, Blue...DB1SP3-LXL-B  
L-XL, Black...DB1SP3-LXL-K  
L-XL, Black/Yellow...DB1SP3-LXL-KY  
L-XL, Orange...DB1SP3-LXL-O  
L-XL, Yellow...DB1SP3-LXL-Y

- Mask "Bora Plus" w. silicone skirt (Mask details page 20)
- Snorkel "Manta Plus" w. Semi-dry top design (Snorkel details page 24)
- Fins "Speed 3" Adjustable, sizes: S-M, L-XL (Fins details page 29)
- Re-useable large mesh bag with shoulder strap

## BORA MASK & SNORKEL SET



**Y**  
**B**  
**K**  
**O**

**Mesh bag:**  
Blue...DB2Bag-B  
Black...DB2Bag-KK  
Black/Yellow...DB2Bag-KY  
Orange...DB2Bag-O  
Yellow...DB2Bag-Y

**Clamshell:**  
Blue...DB2Clam-B  
Black...DB2Clam-KK  
Black/Yellow...DB2Clam-KY  
Orange...DB2Clam-O  
Yellow...DB2Clam-Y

- Mask "Bora Plus" w. silicone skirt (Mask details page 20)
- Snorkel "Manta Plus" w. Semi-dry top design (Snorkel details page 24)
- Clamshell or re-useable mesh bag

## MAKO MASK & SNORKEL SET



**Y**  
**B**  
**K**

**Mesh bag:**  
Blue Trans...DBMakoB-BT  
Black...DBMakoB-KK  
Yellow...DBMakoB-Y

**Clamshell:**  
Blue Trans...DBMakoC-BT  
Black...DBMakoC-KK  
Yellow...DBMakoC-Y

- Mask "Mako" w. silicone skirt (Mask details page 20)
- Snorkel "Mako" w. Semi-dry top design (Snorkel details page 24)
- Clamshell or re-useable mesh bag

## ORCA MASK & SNORKEL SET



**B**  
**Pi**  
**Y**

**Mesh bag:**  
Blue...DBOrcB-B  
Yellow...DBOrcB-KY  
Pink...DBOrcB-Pi

**Clamshell:**  
Blue...DBOrcC-B  
Yellow...DBOrcC-KY  
Pink...DBOrcC-Pi

- Mask "Orca" w. silicone skirt (Mask details page 20)
- Snorkel "Orca" 100% Silicone (Snorkel details page 25)
- Clamshell or re-useable mesh bag

## COVERT MASK & SNORKEL SET



**B**  
**K**  
**Pi**  
**W**

**Mesh bag:**  
Blue...DBCvtB-KB  
Black...DBCvtB-KK  
Pink...DBCvtB-KPi  
White...DBCvtB-KW

**Clamshell:**  
Blue...DBCvtC-KB  
Black...DBCvtC-KK  
Pink...DBCvtC-KPi  
White...DBCvtC-KW

- Mask "Covert" w. silicone skirt (Mask details page 20)
- Snorkel "Covert" 100% Silicone (Snorkel details page 25)
- Clamshell or re-useable mesh bag

## XTREME MASK & SNORKEL SET



**B**  
**Pi**  
**W**  
**Y**

**Mesh bag:**  
Blue...DBXtrB-B  
White...DBXtrB-KW  
Yellow...DBXtrB-KY  
Pink...DBXtrB-Pi

**Clamshell:**  
Blue...DBXtrC-B  
White...DBXtrC-KW  
Yellow...DBXtrC-KY  
Pink...DBXtrC-Pi

- Mask "Xtreme" w. silicone skirt (Mask details page 20)
- Snorkel "Xtreme" w. Dry Top (Snorkel details page 25)
- Clamshell or re-useable mesh bag





## HAWAII MASK & SNORKEL SET



**Mesh bag:**  
Blue Trans...DB3Bag-BT  
Yellow Trans...DB3Bag-YT



- Mask "Hawaii" w. PVC skirt (Mask details page 20)
- Snorkel "Mako" w. Semi-dry top design (Snorkel details page 24)
- Re-useable mesh bag

## FIJI PVC JUNIOR MASK & SNORKEL SET



**Mesh bag:**  
Blue Trans...DB4Bag-BT  
Pink Trans...DB4Bag-PIT  
Yellow Trans...DB4Bag-YT



- Mask "Fiji" w. PVC skirt (Mask details page 20)
- Snorkel "Goby" w. Semi-dry top design (Snorkel details page 24)
- Re-useable mesh bag

## FIJI JUNIOR MASK & SNORKEL SET



**Mesh bag:**  
Blue Trans...DB8Bag-BT  
Pink Trans...DB8Bag-PIT  
Yellow...DB8Bag-Y



**Clamshell:**  
Blue Trans...DB8Clam-BT  
Pink Trans...DB8Clam-PIT  
Yellow...DB8Clam-Y



- Mask "Fiji" w. silicone skirt (Mask details page 20)
- Snorkel "Damsel" w. Semi-dry top design (Snorkel details page 24)
- Clamshell or re-useable mesh bag

## CORAL "JUNIOR" MASK & SNORKEL SET



**Mesh Bag...DBCoralB  
Clamshell...DBCoralC**

- Mask "Coral" w. Silicone skirt (Mask details page 20)
- Snorkel "Coral" w. Semi-dry top design (Snorkel details page 24)
- Re-useable mesh bag





## SPEED 1 SNORKELLING FINs



Y  
B  
K  
Pi



Black, S-M...DBF770-S/M-K  
Black, ML-XL...DBF770-ML/XL-K  
Blue, S-M...DBF770-S/M-B  
Blue, ML-XL...DBF770-ML/XL-B  
Pink, S-M...DBF770-S/M-Pi  
Pink, ML-XL...DBF770-ML/XL-Pi  
Yellow, S-M...DBF770-S/M-Y  
Yellow, ML-XL...DBF770-ML/XL-Y

- Travel-friendly short blade design
- Adjustable strap allows for wide foot range
- Soft & flexible blade
- Ergonomic foot pocket
- Non slip protection
- Ideal for snorkeling

## SPEED 1 JUNIOR SNORKELLING FINs



Y  
G  
Pi



Green, S-M...DBFA22SM-G  
Green, ML-XL...DBFA23MLX-G  
Pink, S-M...DBFA23MLX-Pi  
Pink, ML-XL...DBFA22SM-Pi  
Yellow, S-M...DBFA22SM-Y  
Yellow, ML-XL...DBFA23MLX-Y

- Travel-friendly short blade design
- Adjustable strap allows for wide foot range
- Soft & flexible blade
- Ergonomic foot pocket
- Non slip protection
- Ideal for snorkeling

## SPEED 2 FULL FOOT FINs



Y  
B  
K



Black, XS...DBF367-XS-K  
Black, S...DBF367-S-K  
Black, M...DBF367-M-K  
Black, L...DBF367-L-K  
Black, XL...DBF367-XL-K

Blue, 5XS...DBF367-5XS-B  
Blue, 4XS...DBF367-4XS-B  
Blue, XS...DBF367-XS-B  
Blue, S...DBF367-S-B  
Blue, M...DBF367-M-B  
Blue, L...DBF367-L-B  
Blue, XL...DBF367-XL-B

Yellow, 5XS...DBF367-5XS-Y  
Yellow, XS...DBF367-XS-Y  
Yellow, M...DBF367-M-Y  
Yellow, L...DBF367-L-Y  
Yellow, XL...DBF367-XL-Y

- Soft & flexible blade
- Flexible centre section to channel water
- Ergonomic foot pocket
- Non slip protection
- Ideal for snorkeling

## SPEED 3 ADJUSTABLE FINs



Kids  
BT  
Pi  
Y  
Adults  
BT  
K  
Y  
O



### Adults:

Black, S-M...DBFB86SM-K  
Black, L-XL...DBFB85LX-K  
Blue Trans, S-M...DBFB86SM-BT  
Blue Trans, L-XL...DBFB85LX-BT  
Orange, S-M...DBFB86SM-O  
Orange, L-XL...DBFB85LX-O  
Yellow, S-M...DBFB86SM-Y  
Yellow, L-XL...DBFB85LX-Y

### Kids:

Blue Trans, S-M, ...DBFB87SM-BT  
Blue Trans, M-L...DBFB88ML-BT  
Blue Trans, L...DBFB89L-BT  
Pink Trans, S-M...DBFB87SM-Pi  
Pink Trans, M-L...DBFB88ML-Pi  
Pink Trans, L...DBFB89L-Pi  
Yellow, S-M...DBFB87SM-Y  
Yellow, M-L...DBFB88ML-Y  
Yellow, L...DBFB89L-Y

- Travel-friendly short blade design
- Adjustable strap allows for wide foot range
- Soft & flexible blade
- Ergonomic foot pocket
- Non slip protection

## JET FINs CLASSIC OPEN HEEL



VIRTUALLY INDESTRUCTIBLE  
used by Navy Divers world-wide



LIMITED STOCK  
SPECIAL ORDER



REGULAR STOCK  
K

### REGULAR STOCK:

Black, M...X25.365.300M  
Black, L...X25.365.400L  
Black, XL...X25.365.500XL  
Black, XXL...X25.365.600XXL

### LIMITED STOCK SPECIAL ORDER:

Camo Pink/White, M...X25.372.300M  
Blue Camo, XXL...X25.376.600XXL  
Camo Grey/White, XXL...X25.380.600XXL

- Proven vented design decreases drag on the upstroke & enhances thrust on the down-stroke
- Choice of combat & tactical units worldwide
- Water flows-thru vents on weaker down-stroke
- Vents reduce pressure, providing less strain on the leg
- Angle of the vent acts as a solid blade on up-stroke
- Up-stroke provides maximum power & propulsion
- Ideal for Diving

## GO FINs OPEN HEEL



TOUGH AS NAILS,  
DIVE SCHOOL FAVORITE



Black, Travel 2XS...X25.740.000/2XS  
Black, Travel XS-S...X25.740.150/XS-S  
Black, Travel M-L...X25.740.300/M-L  
Black, Travel XL...X25.740.500/XL  
White, Travel XS-S...X25.741.150XS-S  
White, Travel M-L...X25.741.300M-L  
White, Travel XL...X25.741.500XL

Purple, Rental 3XS...X25.743.090/3XS  
Green, Rental 2XS...X25.743.000/2XS  
Blue, Rental XS-S...X25.743.150/XS-S  
Yellow, Rental M-L...X25.743.300/M-L  
Orange, Rental XL...X25.743.500/XL  
Grey, Rental 2XL...X25.743.600/2XL

### Strap Colours:



- The new phenomenon in fin rental; comfortable, practical durable & affordable
- Monprene® TPE (Thermo plastic Elastomer)
- Made from monprene using single mould construction - virtually indestructible
- Bootless open heel configuration
- Marine grade bungee, name plate, integral storage feature
- Colour coded fin strap colours: Blue, Green, Grey, Orange, Purple, Yellow. Also available in all sizes with a black strap for retail

## GO FINs RESORT SIZE CHART



International Sizing				3XS	2XS	XS-S	M-L	XL	XXL
♂ US	♀ UK	EU							
10 KIDS	8	27	●	---	---	---	---	---	---
11 KIDS	10	28	●	---	---	---	---	---	---
12 KIDS	11	29	●	---	---	---	---	---	---
13 KIDS	12	30	●	○	---	---	---	---	---
1 KIDS	13	31-32	○	●	---	---	---	---	---
2 KIDS	1	33	---	●	---	---	---	---	---
3	4	2	34	---	●	---	---	---	---
4	5	3	35-36	---	●	○	---	---	---
5	6	4	37	---	○	●	---	---	---
6	7	5	38	---	---	●	---	---	---
7	8	6	39-40	---	---	●	○	---	---
8	9	7	41	---	---	○	●	---	---
9	10	8	42	---	---	---	●	---	---
10	11	9	43-44	---	---	---	●	○	---
11	12	10	45	---	---	---	○	●	---
12	13	11	46	---	---	---	---	●	○
13	14	12	47	---	---	---	---	●	●
14	15	13	48-49	---	---	---	---	○	●

## SEAWING NOVA & GORILLA OPEN HEEL FINS



W  
K  
Pi

### Seawing Nova:

Black, XS...X25.731.100XS  
Black, S...X25.731.200S  
Black, M...X25.731.300M  
Black, L...X25.731.400L  
Black, XL...X25.731.500XL  
White, XS...X25.732.100XS  
White, S...X25.732.200S  
White, M...X25.732.300M  
White, L...X25.732.400L  
White, XL...X25.732.500XL  
Pink, XS...X25.735.100XS  
Pink, S...X25.735.200S  
Pink, M...X25.735.300M

- Award-winning design
- Fine-tuned to provide increase in stiffness & snap
- Ergonomic foot pocket with extended heel plate
- Wing tips arc upwards, increasing high-speed stability
- Better frog-kick-ability
- Marine quality bungee heel straps
- Ideal for Diving

## GO SPORT FINS



SCUBALAB  
TESTER'S  
CHOICE  
2019



W K

### Regular Stock:

Black, XS...X25.761.100XS  
Black, S...X25.761.200S  
Black, M...X25.761.300M  
Black, L...X25.761.400L  
Black, XL...X25.761.500XL  
White, XS...X25.762.100XS  
White, S...X25.762.200S  
White, M...X25.762.300M  
White, L...X25.762.400L  
White, XL...X25.762.500XL

### Regular Stock:

Army Green...X25.328.000  
Green...X25.328.010  
Silver...X25.328.025  
Purple...X25.328.050  
Blue...X25.328.200  
Turquoise...X25.328.250  
Orange...X25.328.400  
Yellow...X25.328.500  
Pink...X25.328.700

B Y

### Limited Stock Special Order:

Yellow, XS Sp/O...X25.763.100XS  
Yellow, S Sp/O...X25.763.200S  
Yellow, M Sp/O...X25.763.300M  
Yellow, L Sp/O...X25.763.400L  
Yellow, XL Sp/O...X25.763.500XL  
Blue, XS Sp/O...X25.764.100XS  
Blue, S Sp/O...X25.764.200S  
Blue, M Sp/O...X25.764.300M  
Blue, L Sp/O...X25.764.400L  
Blue, XL Sp/O...X25.764.500XL



- Lightweight design
- Open heel "boot-fit" design
- Self-adjusting bungee heel strap
- Ultra-strong 100% Monprene® construction
- In-water performance delivers speed, power, stability and maneuverability
- Fins fit easily in IATA carry-on compliant luggage.
- Skegs mounted on blade ends minimize sideslip and maximize stability.
- Fins are available in black, blue, yellow or white.

## PROPUTION S OPEN HEEL FINS



Pi K B Y W

S/M, M/L, L/XL - W...B71043  
S/M - B, K, P, Y...B538  
M/L - B, K, Y...B539  
L/XL - B, K, Y...B540



- Large blade for a more powerful response in the water
- Flexible water channels for increased efficiency
- External ribbings for blade support
- Ergonomic open heel foot pocket w.non slip protection
- Ideal for Scuba Diving
- Propution S with rubber strap
- Propution S with sling strap

## F100 PRO FULL FOOT FINS



CHOICE OF  
DIVE PRO'S

Pi K B Y R

Black, 40/41...B9292-K  
Black, 42/43...B9293-K  
Black, 44/45...B9294-K  
Black, 46/47...B9295-K  
Blue, 36/37...B9290-B  
Blue, 38/39...B9291-B  
Blue, 40/41...B9292-B  
Blue, 42/43...B9293-B  
Blue, 44/45...B9294-B  
Blue, 46/47...B9295-B  
Pink, 36/37...B9290-P  
Pink, 38/39...B9291-P  
Red, 36/37...B9290-R  
Red, 38/39...B9291-R  
Red, 42/43...B9292-R  
Red, 40/41...B9293-R  
Yellow, 36/37...B9290-Y  
Yellow, 38/39...B9291-Y  
Yellow, 40/41...B9292-Y  
Yellow, 42/43...B9293-Y  
Yellow, 44/45...B9294-Y  
Yellow, 46/47...B9295-Y



- Researched & created for heavy duty intensive use
- Large blade for a more powerful response in the water
- Flexible water channels for increased efficiency
- Extra solid external ribbings
- Ergonomic foot pocket w. non slip protection
- Ideal for Dive Centres

## JET FINS OPEN HEEL FINS



K

Black, XL...S2030  
Black, L...S2031  
Black, M...S2032

- Durable rubber construction
- Drag-reducing vents
- Soft foot pocket
- Semi rigid side rails for blade stability
- Adjustable rubber heel straps
- Ideal for Diving

## JET FINS PRO OPEN HEEL FINS



Pi K Y G

Black, XL...SJFPRO3/XL-K  
Green, L...SJFPRO2/L-G  
Pink, M...SJFPRO1/M-P  
Pink, L...SJFPRO2/L-P  
Yellow, XL...SJFPRO3/XL-Y

- Material: 100% Rubber
- Proven Vented Design (Excellent propulsion)
- Provides Exceptional Speed with Minimal Effort
- Vents Reduce Pressure, Providing less strain on leg
- Angle of the vent reacts as a solid blade on upstroke
- Slightly positive buoyant in saltwater, neutrally fin in fresh water
- Preferred fin type by Scuba Instructors & Diving Professionals
- Open heel with heavy duty dual bungee cord straps
- Colours: Black, Green, Pink, Yellow
- Sizes: M, L, XL

## SCUBAPRO BOOTS

SCUBAPRO

### High Boots:

3XS/4...X57138/3XS  
2XS/5...X57138/2XS  
XS/6...X57138/XS  
S/7...X57138/S  
M/8...X57138/M  
L/9...X57138/L  
XL/10...X57138/XL  
2XL/11...X57138/2XL  
3XL/12...X57138/3XL



### Short Boots:

3XS/4...X57166/3XS  
2XS/5...X57166/2XS  
XS/6...X57166/XS  
S/7...X57166/S  
M/8...X57166/M  
L/9...X57166/L  
XL/10...X57166/XL  
2XL/11...X57166/2XL



- Delta boot, 5mm comfort & protection, available in 3XS-3XL
- Delta short boot, 3mm low-cut & light weight, available in 3XS-2XL

## DEEP BLUE BOOTS

DEEPBLUE

### Classic Boots:

2XS...DBB01B-XXS  
XS...DBB01B-XS  
S...DBB01B-S  
M...DBB01B-M  
ML...DBB01B-ML  
L...DBB01B-L  
XL...DBB01B-XL  
2XL...DBB01B-XXL



### Nautilus Boots:

2XS...DBB01C-XXS  
XS...DBB01C-XS  
S...DBB01C-S  
M...DBB01C-M  
ML...DBB01C-ML  
L...DBB01C-L  
XL...DBB01C-XL



### Reef Half Boots:

3XS...DBB02A-XXXS  
2XS...DBB02A-XXS  
XS...DBB02A-XS  
S...DBB02A-S  
M...DBB02A-M  
ML...DBB02A-ML  
L...DBB02A-L  
XL...DBB02A-XL  
2XL...DBB02A-XXL



- Nautilus boots, 5mm available in 2XS-XL
- High boots w. orange insert, 5mm available in 2XS-2XL
- Half boots w. pull cord, 3mm available in 3XS-2XL

## SCUBAPRO GLOVES 1.5mm

SCUBAPRO

### Tropic Gloves, Flamingo

2XS...X580340/XXS  
XS...X580341/XS  
S...X580342/S  
M...X580343/M



### Tropic Gloves, Aegean

2XS...X580320/XXS  
XS...X580321/XS  
S...X580322/S  
M...X580323/M  
L...X580324/L



### Tropic Gloves, Black

S...X580352/S  
M...X580353/M  
L...X580354/L  
XL...X580355/XL



### Tropic Gloves

XL...X58325/XL  
2XL...X58325/2XL



### Tropic Gloves, Black

2XS...X58326/XXS  
XS...X58326/XS  
XL...X58326/XL  
2XL...X58326/XXL



### Seamless Gloves

XS...X580001/XS  
S...X580002/S  
M...X580003/M  
L...X580004/L  
XL...X580005/XL



## BOOT SIZE CHART

Size	Deep Blue	Scubapro	Seac
3XS	4	5	n/a
2XS	5	5.5	23/36-37
XS	6	6	24/37-38
S	7	7	25/38-39
SM	n/a	n/a	n/a
M	8	8	26/40-41
ML	9	8.5	n/a
L	10	9	27/42-43
XL	11	10	28/43-44
2XL	12	11	29/45-46
3XL	n/a	11.5	n/a

## DEEP BLUE SOCKS

DEEPBLUE

2XS...DBB03-XXS  
XS...DBB03-XS  
S...DBB03-S  
M...DBB03-M  
L...DBB03-L  
XL...DBB03-XL  
2XL...DBB03-XXL



- Neoprene sock, 2mm Size XXS - XXL

## BEACH WALKER

DEEPBLUE

### Aloha - Orange:

30...DBB04-30  
31...DBB04-31  
32...DBB04-32  
33...DBB04-33  
- etc.  
- -  
44...DBB04-44  
45...DBB04-45  
46...DBB04-46



### Aloha - Blue:

30...DBB05-30  
31...DBB05-31  
32...DBB05-32  
- etc.  
- -  
44...DBB05-44  
45...DBB05-45  
46...DBB05-46



### Aloha - Blue Trim:

35...DBB06-35  
36...DBB06-36  
37...DBB06-37  
38...DBB06-38  
- etc.  
- -  
44...DBB06-44  
45...DBB06-45



- Available in 30, 31, 32, 33, 34, 35, 36, 37, 38, 39, 40, 41, 42, 43, 44, 45, 46

## SEAC BOOTS

SEAC

### High Boots:

2XS...B67900-XXS  
XS...B67900-XS  
S...B67900-S  
M...B67900-M  
L...B67900-L  
XL...B67900-XL  
2XL...B67900-XXL



- Basic HD boots, 5mm available in 2XS-2XL

## SEAC GLOVES

SEAC

### High Boots:

XS...B64600-XS



- Tropic HD glove, 1.5mm Size XS

## DEEP BLUE GLOVES

DEEPBLUE

XS...DBG01-XS  
S...DBG01-S  
M...DBG01-M  
L...DBG01-L  
XL...DBG01-XL



- Tropic glove, 1.5mm Size XS - XL



## UNISEX SHORTY

**BEST SELLER**

DEEPBLUE



2XS...DBADS01-XXS  
XS...DBADS01-XS  
S...DBADS01-S  
M...DBADS01-M  
L...DBADS01-L  
XL...DBADS01-XL  
2XL...DBADS01-XXL  
3XL...DBADS01-XXXL

XS...DBADS02-XS  
S...DBADS02-S  
M...DBADS02-M  
L...DBADS02-L  
XL...DBADS02-XL  
2XL...DBADS02-XXL

3XS...DBADS04-XXXS  
2XS...DBADS04-XXS  
XS...DBADS04-XS  
S...DBADS04-S  
M...DBADS04-M  
L...DBADS04-L  
XL...DBADS04-XL  
2XL...DBADS04-XXL  
3XL...DBADS04-XXXL

- Add your own logo on chest
- 3mm shorty / Black
- Quality CR neoprene (CR = Chloroprene Rubber)
- Back zipper, YKK
- Rolled seams on edges
- Flat comfortable seams
- Sizes: XXS-XXXL
- Size indication on zipper band

- Add your own logo on chest
- 3mm shorty / black w. blue panels
- Standard neoprene
- Back zipper, YKK
- Rolled seams on edges
- Flat comfortable seams
- Sizes: XS-XXL
- Size indication on zipper band

- Add your own logo on chest
- 3mm shorty / black w. blue stitching
- Standard neoprene
- Back zipper, YKK
- Rolled seams on edges
- Flat comfortable seams
- Sizes: 3XS-3XL
- Size indication on zipper band

## UNISEX STEAMER

3mm

DEEPBLUE



XS...DBADS03-XS  
S...DBADS03-S  
M...DBADS03-M  
L...DBADS03-L  
XL...DBADS03-XL  
2XL...DBADS03-XXL  
3XL...DBADS03-XXXL

- 3mm durable black neoprene
- Back zipper
- Rolled seams on edges
- Flat comfortable seams
- Sizes: XS-XXXL
- Size indication on zipper band
- Wrist & ankle zipper

## STEAMER SIZE CHART

Position	XS	S	M	L	XL	XXL	3XL
Chest	84	88	92	96	100	104	108
Waist width	69	73	77	81	85	89	93
Hip width	84	88	92	96	100	104	108
Length of neck to crotch	68	70	72	74	76	78	80
Neck circumference	35	36	37	38	39	40	41

## WETSUIT SIZE CHART

DEEP BLUE SHORTY DBADS01 / DBADS02 / DBADS04

DEEPBLUE

Unit: cm

Position	XXS	XS	S	M	L	XL	XXL	XXXL
Chest	79	83	87	91	95	99	103	107
Waist width	65	69	73	77	81	85	89	93
Hip width	80	84	88	92	96	100	104	108
Length of neck to crotch	65	67	69	71	73	75	77	79
Neck circumference	33	34	35	36	37	38	39	40

## ICON RASHGUARD

DEEPBLUE



Black, M...DBLR2K-M  
Black, L...DBLR2K-L  
Black, XL...DBLR2K-XL  
Black, 2XL...DBLR2K-XXL

Black, 2XS...DBLR1K-XXS  
Black, XS...DBLR1K-XS  
Black, S...DBLR1K-S  
Black, M...DBLR1K-M  
Black, L...DBLR1K-L  
Black, XL...DBLR1K-XL  
Black, 2XL...DBLR1K-XXL

Black/Blue, 2XS...DBLR1KB-XXS  
Black/Blue, XS...DBLR1KB-XS  
Black/Blue, S...DBLR1KB-S  
Black/Blue, M...DBLR1KB-M  
Black/Blue, L...DBLR1KB-L  
Black/Blue, XL...DBLR1KB-XL  
Black/Blue, 2XL...DBLR1KB-XXL

Black/Grey, 2XS...DBLR1KGy-XXS  
Black/Grey, XS...DBLR1KGy-XS  
Black/Grey, S...DBLR1KGy-S  
Black/Grey, M...DBLR1KGy-M  
Black/Grey, L...DBLR1KGy-L  
Black/Grey, XL...DBLR1KGy-XL  
Black/Grey, 2XL...DBLR1KGy-XXL

- The optimal body wear for water sports or any outdoor activities
- Light weight & instant drying
- Tie down loop for surfers
- Colours: Black, Black/Blue, Black/Grey & Black with Blue screen

## LOOSE FIT LYCRA

DEEPBLUE



2XS...DBLRLF-XXS  
XS...DBLRLF-XS  
S...DBLRLF-S  
M...DBLRLF-M  
L...DBLRLF-L  
XL...DBLRLF-XL  
2XL...DBLRLF-XXL

- The optimal body wear for water sports or any outdoor activities
- Light weight & instant drying
- Unisex design
- Tie down loop for surfers
- UPF-50 (Ultraviolet Protection Factor)
- Material: 82% Nylon, 18% Spandex

## EVERFLEX STEAMER 3mm



Men, XS...X63353/XS

Lady, XXS...X63354/L  
Lady, M...X63354/M  
Lady, L...X63354/XXS

- X-Foam eco-friendly neoprene & solvent free glue for better health & environmental protection
- Smooth-cut neckline
- New PVC zip ends adds stylish & durable finishing
- Glideskin seals
- New heliospan torso lining for added protection & insulation
- 3D design shoulder pads & Tatex kneepads
- Powertex anti-abrasion
- 2x I-Safe straps
- Compression lumbar & spine pad

## THERMAL TEC STEAMER 3mm & 5mm



Lady, 5mm, XL...X64464XL

Men, 3mm, L...X64470L  
Men, 3mm, XL...X64470XL  
Men, 5mm, XL...X64473XL

A serious suit for serious divers. The Thermal TEC is a perfect combination of advanced materials & thoughtful construction, creating a suit of outstanding durability, comfort & insulation. Main suit sections are made of durable & fast drying N2S neoprene. Wrist & ankle zippers for divers ease of wear.

## PROFILE 0.5mm



Lady, 2XS...X63447/XXS  
Men, S...X630372/S  
Men, M...X630373/M  
Men, L...X630374/L  
Men, XL...X630375/XL

- 0.5mm nylon neoprene outside for durability & Silverskin inside for easy wear. Silverskin is an ultra-smooth interior finish. It consists of a cell finish with 'metalite' coating for extra warmth retention. It dries fast & seals extremely well. It is also used on hood & glove interiors
- Non-chaffing flat seams for insured comfort directly against your skin. Flat seam construction is a stitching pattern that provides comfort, strength & flexibility on warm water suits
- Thumb & foot straps, for added convenience
- Back zipper for great ergonomics
- Men's & women's dedicated sizes & colours

## DEFINITION 3mm



Men, S...X639302/S  
Men, M...X639303/M  
Men, L...X639304/L  
Men, XL...X639305/XL  
Men, 2XL...X639306/XXL

Lady, 2XS...X639310/XXS  
Lady, XS...X639311/XS  
Lady, S...X639312/S  
Lady, M...X639313/M  
Lady, L...X639314/L

- Made from X-Foam neoprene, the only "green" neoprene that complies with P.A.H. regulations
- The "body map" system uses special tailoring & material inserts to compensate for the stresses of the human body
- Ultraspan chest panel & Stretchtec side panels work together to produce a highly flexible & snug fit
- Infrared (IR) fleece interior lining reflects body heat for extra thermal insulation & is extremely soft against the skin
- Zippered seals at wrists & ankles plus a rear diagonal zipper block water entry, are comfortable & make the suit easy to put on & take off
- Abrasion resistant fabric on shoulders & seat, along with elbow pads & kneepads, increase long-term durability
- Spine pad cushions the tank, providing a ditional comfort during extended dives
- Small neck zipper enhances topside comfort, eliminating the need to remove the suit between dives
- I-Safe strap keeps a wrist instrument securely attached

## EVERFLEX STEAMER 3/2mm



Men, S...X634822/S  
Men, M...X634823/M  
Men, L...X634824/L  
Men, XL...X634825/XL  
Men, 2XL...X634826/XXL

Lady, 2XS...X634810/XXS  
Lady, XS...X634811/XS  
Lady, S...X634812/S  
Lady, M...X634813/M

- Made with 100% Everflex neoprene and are assembled using solvent-free water-based Aqua glue.
- Multi-thickness panels deliver a superior combination of warmth and flexibility.
- The Innovative Pure Design Concept uses fewer seams and panels for maximum range of motion.
- Double blind-stitched outer seams, and single blind-stitched inner seams are durable, watertight and comfortable against the skin.
- The Diamond Span inner lining's water-draining material enhances cold water protection and improved stretch.
- Wrists and ankles feature fuse-cut finished cuffs that are super-stretchy.
- A small neck zipper enhances topside comfort.
- Diagonal rear YKK zipper with brass slider offers increased long-term durability and ease of use.
- Compression-molded zipper flap/spine pad reduces water entry and increases back protection.
- Tatex knee and shoulder pads offer protection against abrasion.
- Seat area is protected by an abrasion-resistant outside lining to increase durability and extend the life of the suit.

## HYBRID SHORT w. CARGO POCKETS

S...X653512S  
M...X653513M  
L...X653514L  
XL...X653515XL



Unique styling keeps you warm, comfortable & looking good. Worn alone or over a dive suit, their added pockets are a diver's favorite.

## HYBRID SHORTS w. CARGO POCKETS & Belt

S...X653532S  
M...X653533M  
L...X653534L  
XL...X653535XL  
2XL...X653536XXL

**NEW**



- Large, teardrop-shaped Ultra Clear lenses
- Soft silicone skirt uses a double-seal system
- Traditional buckles attach to the skirt
- Wide headband allows for a comfortable fit

## HOODED VEST

2XS...X64062XXS  
XS...X64062XS  
S...X64062S  
M...X64062M  
ML...X64062ML  
L...X64062L  
XL...X64062XL  
2XL...X64062XXL  
3XL...X64062XXXL



- 2.5mm throughout
- 100% Everflex neoprene
- Light graphic print on side panels & head
- Glide skin interior (black)

## HOOD EVERFLEX 5/3mm

S...X67.052.200S  
M...X67.052.300M  
L...X67.052.400L  
XL...X67.052.500XL



- Constructed of high-stretch 100 percent Everflex neoprene for maximum comfort & durability
- Extremely stretchy Silverskin lining feels good against the skin & provides a good seal to minimize water transfer

## T-FLEX LONG SLEEVE



**Lady, Blue/White**  
XS...X63280/XS

**Lady, Black**  
XL...X63264/XL

**Men, Black**  
XS...X63283/XS

- Scubapro-designed T-Flex Rash Guard / Lycra shirt
- High quality, UV-rated FlexTec shirts with close-to-body fit to wear under a suit for added warmth, or used solely as a rashguard for your snorkeling & swimming activities
- Extremely flexible & stretchy, making it super comfortable to wear
- Available with long sleeves & in various colour combinations with two-colour style accents & contrasting outside stitching

## MICROFIBER TOWEL

- Large 160x80cm, Blue



X50.582.000

## RASHGUARD LONG SLEEVE UPF 50

**NEW**



**Men, Graphite**  
S...X650322/S  
M...X650323/M  
L...X650324/L  
XL...X650325/XL  
2XL...X650326/XXL



**Men, Aegean**

S...X650332/S  
M...X650333/M  
L...X650334/L  
XL...X650335/XL  
2XL...X650336/XXL



**Men, Black**

S...X650312/S  
M...X650313/M  
L...X650314/L  
XL...X650315/XL  
2XL...X650316/XXL

- UPF 50 rating (blocks 98% of UV radiation)
- High quality polyester: durable, abrasionresistant, good color fastness
- Form-fitting design wears easily under a wetsuit & retains its shape after repeated use
- Flattering color panels & high neck line to prevent uncomfortable chafing
- Material dries quickly to enhance comfort between dives

## T-FLEX UPF 80 LONG SLEEVE



**Men, Black**

S...X652312/S  
M...X652313/M  
L...X652314/L  
XL...X652315/XL  
2XL...X652316/XXL

**Men, Graphite**

S...X652322/S  
M...X652323/M  
L...X652324/L  
XL...X652325/XL  
2XL...X652326/XXL

**Lady, Onyx**

XS...X657361/XS  
S...X657362/S  
M...X657363/M  
L...X657364/L  
XL...X657365/XL

- Look sharp while enjoying outstanding protection with the stylish T-FLEX rashie. Made from water-repellant Flex-Tec, the T-FLEX doesn't trap water & it dries quickly
- The thumb-hole wrist design on the long sleeve models makes it easy to wear beneath a wetsuit. When topside, its UPF80 (Ultraviolet Protection Factor) rating provides ample protection from the sun's rays



## T-FLEX LONG SLEEVE



**Black/Blue**  
XS...X63180/XS  
M...X63180/M

- Scubapro-designed T-Flex Rash Guard / Lycra shirt
- High quality, UV-rated FlexTec shirts with close-to-body fit to wear under a suit for added warmth, or used solely as a rashguard for your snorkeling & swimming activities
- Extremely flexible & stretchy, making it super comfortable to wear
- Available with long sleeves & in various colour combinations with two-colour style accents & contrasting outside stitching

## SWIM UPF 50 LONG SLEEVE



S...X620312/S  
M...X620313/M  
L...X620314/L  
XL...X620315/XL  
2XL...X620316/XXL

- Stylish polyester skin protection; increases comfort when diving & on the surface
- UPF 50 rating blocks 98% of UV radiation
- Features a chlorine-resistant treatment for pool training
- High quality polyester offers good color fastness
- Durable, abrasion-resistant, retains its shape after repeated use & wears easily under a wetsuit
- Highly versatile – ideal for divers, snorkelers, paddle boarders, swimmers & other water enthusiasts too

## RASHGUARD LONG SLEEVE UPF 50



**Lady, Flamingo**  
XS...X655371/XS

A garment with a rating of UPF 50 blocks 98% of UV radiation. UPF ratings 50 & above are considered to be in the "Excellent" Protection Category.

- Stylish skin protection increases comfort during diving
- Made from high quality polyester fabric
- Form-fitting
- Dries quickly

FUNCTIONAL GEAR THAT LOOKS GREAT

## T-FLEX UPF 80 LONG SLEEVE



**Lady, Caribbean T Flex**  
XS...X657351/XS

- UPF 80 rating (awarded by UV standard 801)
- Made from a blend of 86% super-soft nylon & 14% highstretch spandex
- The nylon is lightweight & quick drying
- The spandex provides more fabric stretch & allows for comfort & form-fitting styling
- Exceptional strength, abrasion resistance moisture control
- Form-fitting for that sleek hydrodynamic look & feel
- Slimming color panels & cut compliment the female body

## LOVE T-SHIRT



Size 2XS, Blue...X003.34-2XS  
Size XS, Blue...X003.36-XS  
SSize S, Blue...X003.38-S  
Size M, Blue...X003.40-M  
Size L, Blue...X003.42-L  
Size XL, Blue...X003.44-XL  
Size 2XL, Blue...X003.46-2XL  
Size 3XL, Blue...X003.48-3XL  
Size 4XL, Blue...X003.50-4XL  
Size 2XS, Pink...X004.34-2XS  
Size XS, Pink...X004.36-XS  
SSize S, Pink...X004.38-S  
Size M, Pink...X004.40-M  
Size L, Pink...X004.42-L  
Size XL, Pink...X004.44-XL

- 100% Cotton, 150 GSM
- Scubapro logo on front
- "LOVE" on back
- Available in Blue and Pink screen

## SCUBAPRO T-SHIRT



2XS...X002.34-2XS  
XS...X002.36-XS  
S...X002.38-S  
M...X002.40-M  
L...X002.42-L  
XL...X002.44-XL  
2XL...X002.46-2XL  
3XL...X002.48-3XL  
4XL...X002.50-4XL

- 100% Cotton, 150 GSM
- "Deep Down You Want The Best" on front
- Scubapro logo on back

## CAMO LONG SLEEVE



S...X636602/S

- Ultra UV protection rating SPF80
- Breathable high-tech hollow fiber
- Extremely water resistant, quick-drying

## T-FLEX UPF 80 LEGGINGS



**Lady, Caribbean**  
XS...X657751/XS  
S...X657752/S  
L...X657754/L

**Lady, Jewel**  
XS...X657791/XS  
S...X657792/S  
M...X657793/M

- Rated UPF 80 by UV Standard 801 - the highest UV protection rating available in the industry
- Made from a blend of 86% super-soft nylon & 14% high-stretch spandex
- Maximum comfort - maximum stretch
- Looks great with the T-Flex rash guards
- Slimming color panels & cut compliment a female's body
- Highly versatile - ideal for divers, snorkelers, swimmers & other water enthusiasts

## TG-6 STYLUS TOUGH CAMERA

OLYMPUS



- 12MP - 1/2.3 BSI-CMOS sensor
- ISO 100 - 12800
- 25-100 mm F2.0-4.9 zoom lens
- Sensor-shift image stabilization
- 3 Fixed type screen
- 20.0 fps continuous shooting
- 4K - 3840 x 2160 video resolution
- Built-in wireless
- Built-in GPS
- 253g 113 x 66 x 32mm
- Weather sealed body



Black...OL-TG6-K  
Red...OL-TG6-R

## HOUSING UNDERWATER

OLYMPUS



OL-PT059

- For TG-6 digital camera
- Depth rating: 45m
- Retains access to all camera controls
- Can accommodate 2 external flashes
- Supports optional lens accessories
- Dimensions: 6.2 x 4.8 x 3.2" / 157 x 122 x 81mm
- Weight: 1.1 lb / 484g

## TG-6 STYLUS TOUGH CAMERA SET

OLYMPUS

Black...OL-TG6Set-K  
Red...OL-TG6Set-R



- TG-6 digital camera
- Underwater housing



## M2500 WSRBA SMART FOCUS VIDEO LIGHT

OLYMPUS



OL-M2500

- Emission angle: 100°
- Color temperature: 5500K
- Total luminous flux/burn time: Wide light: 2500lm (3 levels of brightness) @60min (SupportAuto Shut-off) Red light: 200lm (3 levels of brightness) @250min. (SupportAuto Shut-off)
- Blue Light: 6W @120min
- Battery level indication
- Control methods: 2 x push buttons
- Power supply: Rechargeable Li-ion battery, 3.7V 5000mAh
- Depth rated: 100m, IPX8 (JIS protection class 8)
- 1 x Li-ion battery, 1 x USB charger, 1 x YS adapter, 2 x spare o-rings

## UFL-3 UNDERWATER STROBE

OLYMPUS



OL-UFL3

- Depth rating: 246' / 75m
- Guide number: 22 m / 72' at ISO 100 when used above water at full power
- Effective flash range: not specified by manufacturer
- Angle of coverage: above water: equivalent to that of a 24mm lens (35 mm format)
- Color temperature: 5400K
- Connectivity: PTCB-E02 fiber-optic cable (not included)
- Flash Modes: TTL, Slave & Manual: 10 steps
- Mounting: YS mount (bolt included)
- Recycle time: approx. 2.0 sec
- Power source: 4 AA alkaline, NiMH, lithium, or oxy nickel hydroxide (Oxyride) batteries (not included)
- Dimensions: 2.7 x 4.3 x 5.2" / 6.9 x 10.9 x 13.2cm
- Weight: 1.0lb / 0.45kg

## WIDE ANGLE WET LENS

OLYMPUS



OL-UWL400A

- Description: 0.50X underwater wide angle conversion wet lens
- Lens Coating: all glass lens elements with multi-layers AR coating
- Front PC dome lens with hard coating
- Field of view (diagonal): underwater 120° (with 25mm lens)
- Magnification: 0.50X (on land / underwater)
- Mount system: M52 thread
- Bezel / body material: ABS / hard anodized aluminum alloy
- Weight: 591g (on land) / 200g (underwater)
- Dimensions: 121.8mm (D) X 76mm (H)
- Standard accessories
- Neoprene dome cover, rear cap, lens secure line (LSL-03)

## SEA TOUCH 2 PRO

OLYMPUS



OL-ST2PRO80

- Underwater touch screen
- Underwater touch screen focus
- Access to all apps underwater
- Wireless charge
- Waterproof 80m
- Button free design
- Pressure balance
- Interchangeable lens
- Waterproof pretest system
- IPX8 Standard
- Touch screen life 100,000 times
- Weight 290g
- Applicable model iPhone 6s / 7 / 8 / 6s+ / 7+ / 8+ / X / XR / XS / XS MAX

## SEATOUCH 2 PIONEER

OLYMPUS



OL-ST2PIO10

- Underwater touch screen
- Underwater touch screen focus
- Access to all apps underwater
- Wireless Charge
- Waterproof 10m
- Button free design
- Pressure balance
- IPX8 Standard
- Touch screen life 100,000 times
- Weight 290g
- Applicable model iPhone 6s+ / 7+ / 8+ / X / XR / XS / XS MAX

## ACCESSORIES FOR OLYMPUS CAMERA

OLYMPUS



- OL-MACRO
- OL-WIDE
- OL-L12
- OL-L09
- OL-L06
- OL-RED-HI / OL-RED-STD
- OL-UC92
- OL-QRS
- OL-TR03
- OL-Shoe
- OL-POL058
- OL-CL01
- OL-CHARGER
- OL-L192B
- O-ring TG5/TG6...OL-POL058
- Spare Battery...OL-L192B
- Handle Tray Set...OL-TR03
- Shoe Base Ball...OL-Shoe
- Double Ball Arm 6"...OL-L06
- Double Ball Arm 9"...OL-L09
- Double Ball Arm 12"...OL-L12
- Aluminium Clamp (Black)...OL-CL01
- Fiber Optic Cable Adap. for TG...OL-FCA01
- Quick Release System for AO1 UWL-400a...OL-QRS
- Lithium-Ion Battery Charger for LI-92B (Fast: 5 Hrs)...OL-UC92
- Fibre Optic Cable II/M (Length 453mm/17.8 inch)...OL-5012B
- Wide Angle Lens Set, 105 degree, for SeaTouch PRO...OL-WIDE
- Macro Lens Set, stackable, for SeaTouch PRO...OL-MACRO
- Adapter for ST PRO 37cm...OL-ADAP37
- SeaLense™ High End Red Filter for ST2...OL-RED-HI
- SeaLense™ Filter Red for ST2...OL-RED-STD
- SeaCharge™ Wireless Charging - Water Repellent...OL-CHARGER

## ACCESSORIES FOR CAMERA

INTOVA



- Chest Strap...MSSP1-CS
- Intova Pod...MSSP1-INTPOD
- Helmet Mount...MSSP1-HELM
- Bar / Pole Mount...MSSP1-HBM
- Camera Hand Strap...MSSP1-CHS
- Tripod Mount Adapter...MSSTMA
- Floating Multi Grip...MSSFMG01
- Silica Sticker 5 pack...MSSTKR
- Camera Care Kit...MSSCKK
- Extension Pole...MSSP1EXT

## ACCESSORIES FOR CAMERA

nauticam



- Easitray II with left handle (with 2pcs 1/4" screws)...ONAU.71206
- Flexitray II with left handle (with 2pcs 1/4" screws)...ONAU.71207
- Adjustable right handle II (for Easitray II & Flexitray II)...ONAU.71208
- Strobe mounting ball for Easitray & Flexitray...ONAU.71311
- 200mm double ball arm...ONAU.72204
- 300mm double ball arm...ONAU.72205
- 50mm single ball arm...ONAU.72301
- Standard clamp...ONAU.72501
- Long standard clamp...ONAU.72503
- Triple Clamp...ONAU.72505
- Strobe mounting ball for cold shoe...ONAU.25311
- Light mounting stem for cold shoe...ONAU.25312
- 18cm lanyard with 2 snap hooks...ONAU.25411
- 23cm lanyard with 2 snap hooks...ONAU.25412
- Long light mounting stem for cold shoe...ONAU.25321
- Long strobe mounting ball for cold shoe...ONAU.25322
- Nauticam lubricant (Christo Lube)...ONAU.25016



## GEAR BAG



**K B R**

Blue...DB8020-B  
Black...DB8020-K  
Red...DB8020-R

- Add your custom logo
- Oversize gearbag, 70 x 35 x 35cm (~ 90L)
- Colours: Black, Blue & Red

## GEAR BAG



**K B R**

Blue...DB8010-B  
Black...DB8010-K  
Red...DB8010-R

- Add your custom logo
- Large gearbag, 70 x 30 x 30cm (~ 65L)
- Colours: Black, Blue & Red

## MESH GEAR BAG



- Nylon mesh gear bag
- Lightweight & tough
- Length 63cm

DBBL3176

## REGULATOR BAG



DB8001

- Designed for optimum protection of your regulator
- 8.5L capacity size 32 x 32 x 10cm

## SNORKELING BAG



**K B**

Blue...DB8040-B  
Black...DB8040-K

- Lightweight & convenient for mask, snorkel & fins 75 x 25cm
- Colours: Black & Blue

## MESH BAG



Blue 48x20cm...DB8065-B  
Yellow 48x20cm...DB8065-Y  
Blue 70x30cm...DB8066-B

- DB8065: fits mask & snorkel 48 x 20cm with shoulder strap, colours: Blue & Yellow
- DB8066: fits mask, snorkel & fins 70 x 30cm with shoulder strap, colour: Blue



**B Y**

## WATERPROOF POUCH



**K B**

Blue...DB8044-B  
Black...DB8044-K  
Custom Logo...DB8044-C

- Perfect to store your documents & course materials
- Add your custom logo
- Size: 38 x 30cm

## ADVENTURE BACK PACK

Blue...DBBACK1-B  
Sky Blue...DBBACK1-BL  
Citrus...DBBACK1-Ci  
Black...DBBACK1-K  
Yellow...DBBACK1-Y

**BL Ci K Y B**

- Super heavy duty waterproof fabric
- 100% waterproof RF-welded seams
- Additional outside pocket w. waterproof zipper
- Folding locking system
- Comfortable shoulder straps
- Sternum strap
- Air-Net padded backpack
- Protects contents from water, sand, dust & dirt
- Not suitable for full submersion



## ADVENTURE DRY PACK

For Custom Print



	5L	10L	15L
Blue	DBBV05-B	DBBV10-B	DBBV15-B
Black	DBBV05-K	DBBV10-K	DBBV15-K
Red	DBBV05-R	DBBV10-R	DBBV15-R
Yellow	DBBV05-Y	DBBV10-Y	DBBV15-Y
Sky Blue	DBBV05-BL	DBBV10-BL	DBBV15-BL
Citrus	DBBV05-Ci	DBBV10-Ci	DBBV15-Ci
Orange	DBBV05-O	DBBV10-O	DBBV15-O
Pink	DBBV05-Pi	DBBV10-Pi	DBBV15-Pi
Purple	DBBV05-Pu	DBBV10-Pu	-

- Super heavy duty waterproof fabric
- 100% waterproof RF-welded seams
- Perfect for all outdoor activities
- Folding locking system
- Shoulder strap included
- Protects contents from water, sand, dust & dirt
- Not suitable for full submersion



	1.5L	3L	5L	10L	15L	20L	30L	40L
Blue	DBBA02-B	DBBA03-B	DBBA05-B	DBBA10-B	DBBA15-B	DBBA20-B	DBBA30-B	DBBA40-B
Black	DBBA02-K	DBBA03-K	DBBA05-K	DBBA10-K	DBBA15-K	DBBA20-K	DBBA30-K	DBBA40-K
Red	DBBA02-R	DBBA03-R	DBBA05-R	DBBA10-R	DBBA15-R	DBBA20-R	DBBA30-R	DBBA40-R
Yellow	DBBA02-Y	DBBA03-Y	DBBA05-Y	DBBA10-Y	DBBA15-Y	DBBA20-Y	DBBA30-Y	DBBA40-Y
Sky Blue	DBBA02-BL	DBBA03-BL	DBBA05-BL	DBBA10-BL	DBBA15-BL	-	-	-
Citrus	DBBA02-Ci	DBBA03-Ci	DBBA05-Ci	DBBA10-Ci	DBBA15-Ci	-	-	-
Orange	DBBA02-O	DBBA03-O	DBBA05-O	DBBA10-O	DBBA15-O	-	-	-
Pink	DBBA02-Pi	DBBA03-Pi	DBBA05-Pi	DBBA10-Pi	DBBA15-Pi	-	-	-
Purple	DBBA02-Pu	DBBA03-Pu	DBBA05-Pu	DBBA10-Pu	-	-	-	-



## WATERPROOF POUCH



DBBA01-O

- Perfect for all outdoor activities
- Waterproof ultra light 210T polyester w. clear window
- Durable, wipe clean & easy to store away
- Folding locking system
- Shoulder strap included
- Protects contents from water, sand, dust & dirt
- Not suitable for full submersion

## ADVENTURE BACK PACK



- PHUKET
- KRABI
- KOH LIPE

	Krabi		Lipe		Phuket	
	5L	10L	5L	10L	5L	10L
Sky Blue	DBBC05Kr-BL	DBBC10Kr-BL	DBBC05Li-BL	DBBC10Li-BL	DBBC05Ph-BL	DBBC10Ph-BL
Citrus	DBBC05Kr-Ci	DBBC10Kr-Ci	DBBC05Li-Ci	DBBC10Li-Ci	DBBC05Ph-Ci	DBBC10Ph-Ci
Orange	DBBC05Kr-O	DBBC10Kr-O	DBBC05Li-O	DBBC10Li-O	DBBC05Ph-O	DBBC10Ph-O
Yellow	DBBC05Kr-Y	DBBC10Kr-Y	DBBC05Li-Y	DBBC10Li-Y	DBBC05Ph-Y	DBBC10Ph-Y

## WATERPROOF BAG FOR CAMERA / PHONE



Black...DBNCA-L-K  
Yellow...DBNCA-L-Y

- 100% waterproof bag
- Fits most pocket size cameras
- Vision panel to allow clear photographs or video
- Protects contents from water, sand, dust & dirt
- Adjustable nylon lanyard included
- Protected against water submersion (IPX-8)
- Sizes: Large

## WATERPROOF EARPHONES



w/o Microphone...DBNEARP2

w. Microphone...DBNEARP

- The 3.5mm stereo jack provides compatibility with most smart phones & music players
- 100% waterproof to 3m (10ft)
- On/Off switch for clarity when using a telephone
- Excellent sound quality in & out of water

## REGULATOR BAG W. INSTRUMENT BAG



X53.309.000

- Constructed from a combination of 420D Nylon NT & 450D Rip-stop
- The interior lining is 150D Polyester
- Internal Velcro straps secure a coiled regulator or console with hoses
- Double slider zipper
- Padded handle & shoulder strap
- Transparent zippered pouch inside
- Regulator Bag dimensions: 35 x 26 x 10cm, Weight: 0.35kg
- Instrument Bag dimensions: 11.5 x 7 x 15cm, Weight: 0.1kg

## TRAVEL REGULATOR VINTAGE BAG



X53.309.100

- Constructed of 500D water-resistant tarpaulin with a lined interior to hold all the essentials
- Dimensions: 32 x 32 x 10cm, Weight: 0.8kg

## CARRY-ON FOLDABLE BAG



X53.338.190

- 120D Nylon
- 600D Polyester Straps
- Designed to fit/slide on top cabin bag handle
- Great reusable shopping bag too

## PORTER BAG MEDIUM



NEW

FOLDED

X53.310.190

- Bag's exterior is made from a combination of 420D Nylon NT and 450D Rip-stop fabric for strength and durability. The interior lining is 150D Polyester fabric.
- Offering lots of gear carrying capacity, the bag folds into a compact package for storage.
- Large main compartment, two front pockets and two inside pockets provide a variety of packing and stowage options.
- YKK Vislon saltwater-resistant double-slider zipper is durable and makes accessing the large main compartment that much easier.
- Backpack system plus top handle with rein forced "off-road" skate-style wheels provide multiple transport options.
- Adjustable top handle makes rolling easy and convenient.
- Dimensions (approximate): 32x18x14in / 80x45x35cm. Weight: 5.51lbs/2.5kg. Volume: 33.0gal/125L.
- Folded dimensions (approximate): 20.4x16.1x6.7in / 52x41x17cm.

## DIVE'N ROLL BAG LITE



X53.360.170

REMOVABLE BACKPACK INCLUDED

- Two in one concept, rigid case + detachable backpack
- Exterior material combination of 420D Nylon NT, 450D Ripstop & 600D Polyester/PU
- Inside lining 150D Polyester/PU
- Coil double slider zippers
- Telescopic handle & reinforced saltwater resistant wheels
- 1 main rigid case + 1 detachable backpack
- Dimensions: 66 x 40 x 32cm, Weight: 3.98kg, Volume 84L

## CARAVAN BAG



X53.350.120

- Ideal travel bag with large volume
- Exterior material combination of 420D Nylon NT, 450D Ripstop & 600D Polyester/PU
- Inside lining 150D Polyester/PU
- YKK salt water resistant double slider zippers
- Polyester thread
- External compression straps, retractable double bar trolley handle, side, top & bottom carry handles & reinforced saltwater resistant wheels
- Main compartment with U-shaped top, 2 sides + 1 top flat pockets
- Dimensions: 70 x 40 x 35cm Weight: 3.9kg, Volume 98L

## MESH SACK



X53.369.000

- Bag opening secures with a top rope fitted with a sliding, spring-loaded button closure
- Main compartment handles the larger-sized gear while the front exterior pocket is perfect for small items
- Padded shoulder strap makes it easy to sling the bag for the hike down to the boat or beach
- Folds into a compact size for storage
- Dimensions: 66 x 39cm diameter Weight: 0.5kg, Volume 80L

## DRY BAG BACK PACK



X53.399.180



- Made of 500D heavy-duty PVC Tarpaulin
- Watertight due to heat sealed construction
- Padded backpack system equals convenient, hands-free carrying
- Roll-and-close opening makes for easy access to contents
- Dimensions: 76 x 33 x 20cm, Weight: 0.61kg, Volume 45L

## MESH BAG



X53.379.000



- Made of nylon mesh
- Top loading with U-shaped zipper
- Saltwater-resistant YKK vision zipper features double sliders
- Padded carry handles
- Dimensions: 70 x 40 x 30cm Weight: 0.45kg Volume 84L

## DUFFLE BAG HD



X53.339.190

- Made of a durable yet lightweight combination of 420D nylon NT, 450D Ripstop and 600D polyester with polyester thread stitching
- Inside lining is made of 150D polyester/PU
- Ultra-soft construction makes it super easy to fold and store when not being used
- Main zippers are YKK saltwater resistant and feature double sliders for easy access
- Padded carry handle lets you conveniently tote or lift the bag over uneven terrain
- Dimensions: 80 x 40 x 35cm Weight: 900g Volume: 112L

## CABIN BAG 4 WHEELS



X53.365.170



- Made of 500D heavy-duty PVC Tarpaulin
- Retractable double bar trolley handle with reinforced in-line skate wheels, side & top carry handles
- Large main compartment with U-shaped double-slide coil zipper
- Smaller pockets on the inside & outside
- Conforms to new IATA size regulations
- Side & top carry handles make easy work of lifting the bag into overhead compartments
- Dimensions: 53 x 37 x 19cm, Weight: 3.18kg, Volume 37L

## MICRO CASE



- N1010: 11.1 x 7.3 x 4.3cm
- N1020: 13.5 x 9.0 x 4.3cm
- N1030: 16.2 x 6.7 x 5.2cm
- N1040: 16.5 x 9.8 x 4.4cm

	N1010	N1020	N1030
Blue	N1010-B	N1020-B	N1030-B
Black	N1010-K	N1020-K	-
Red	-	N1020-R	N1030-R



N1010



N1020



N1030

## CABLE PADLOCK



N1506TSA

- Fits all Pelican cases
- TSA approved
- No key required; choose from 999 combinations



## CASE 1120



N1120

- Interior: 18.5 x 12.1 x 8.5cm
- Exterior: 21.4 x 17.2 x 9.8cm
- Colour: Black

## CASE 1150



N1150

- Interior: 21.1 x 14.7 x 9.5cm
- Exterior: 24 x 19.8 x 10.9cm
- Colour: Black

## CASE 1170



N1170

- Interior: 26.8 x 15.3 x 8cm
- Exterior: 29.6 x 21.2 x 9.6cm
- Colours: Black, Orange, Yellow

## CASE 1200



N1200

- Interior: 23.5 x 18.1 x 10.5cm
- Exterior: 27 x 24.6 x 12.4cm
- Colour: Black

## CASE 1300



N1300

- Interior: 23.3 x 17.8 x 15.5cm
- Exterior: 27 x 24.6 x 17.4cm
- Colour: Black

## CASE 1400



N1400

- Interior: 30 x 22.5 x 13.2cm
- Exterior: 34 x 29.5 x 15.2cm
- Colour: Black

## CASE 1450



N1450

- Interior: 37.2 x 26 x 15.5cm
- Exterior: 41.8 x 33 x 17.3cm
- Colour: Black

## LAPTOP CASE



N1490CC#2

- Interior: 45.1 x 28.9 x 10.5cm
- Exterior: 50.5 x 35.4 x 11.9cm
- Colour: Black

## CASE 1500



N1500

- Interior: 42.5 x 28.4 x 15.5cm
- Exterior: 47 x 35.7 x 17.6cm
- Colour: Black

## CASE 1510



N1510

- Interior: 50.2 x 27.9 x 19.3cm
- Exterior: 55.9 x 35.1 x 22.9cm
- Colours: Black, Tan

## CASE 1520



N1520

- Interior: 45.9 x 32.7 x 17.1cm
- Exterior: 50.2 x 40.1 x 18.8cm
- Colour: Black

## CASE 1560



N1560

- Interior: 50.6 x 38 x 22.9cm
- Exterior: 56.1 x 45.5 x 26.5cm
- Colour: Black

## CASE 1600



N1600

- Interior: 54.6 x 42 x 20.3cm
- Exterior: 62 x 49.2 x 22.3cm
- Colour: Black

## CASE 1610



N1610

- Interior: 55.3 x 42.4 x 27cm
- Exterior: 63.1 x 50 x 30.2cm
- Colour: Black

## CASE 1620



N1620

- Interior: 54.6 x 41.7 x 31.9cm
- Exterior: 62.9 x 49.7 x 35.3cm
- Colour: Black



**PELICAN**  
You break it, we replace it...forever.





## STORM LED LIGHT 1050 LUMENS

DEEPBLUE

DBBRDIV05



- Aviation aluminum body
- Battery type: 1 x 18650 lithium battery (included)
- Charger for 18650 (included)
- Waterproof to 150m (500ft)
- Drop resistant 1.5m
- Burn time 2 hrs
- LED Cree XM-L2
- Tempered glass
- Rotary switch

## FUSION 400 400 LUMENS

TQVATEC



MSSFUS400



- Four way visual battery charge indicator
- Use with both lithium-ion and alkaline batteries
- 400 lumen output
- Adjustable 12 degree (narrow beam) to 100-degree beam angle (wide beam)
- 100%, 50%, 30% power level
- Emergency strobe

## FUSION 1500 1500 LUMENS

TQVATEC

MSSFUS1500



- 1500 lumens of maximum power
- 180 minutes of autonomy at 100%
- Lit in 3 positions 100%, 50%, 30% and SOS
- Submersible up to 100m
- Measures 190mm x 40mm (48mm head)
- Weight: 490 grams without batteries
- Battery 26650 of 4500mAh (included)
- Supports the 32650 battery (not included)
- Can work with three AA batteries
- USB and 220v charger

## TORNADO LED LIGHT 1050 LUMENS

DEEPBLUE

DBBRDIV125



- Battery type: 1 x 18650 lithium battery (included)
- Charger for 18650 (included)
- Battery indicator: Green 100-30%, Red 30-10%, Flashing Red > 10%
- Waterproof to 100m (330ft)
- Burn time Full 2 hrs, Low 5 hrs
- Drop resistant 1.5m
- Aviation aluminum body
- LED Cree XM-L2
- Push switch
- Tempered glass

## LED FLASHING LIGHT

SAEWSAVE

SAL-73



- Automatically turns on in water
- Diameter 2.54 x 4.3cm
- Bright flashing LED
- Depth: approx. 60m (200ft)
- Life rating: 300hrs
- Led colour: Green

## FUSION 1050 1050 LUMENS

TQVATEC

MSSFUS1050



- 1050 lumens of maximum power
- 150 minutes of autonomy at 100%
- Lit in 3 positions 100%, 50%, 30% and SOS
- Submersible up to 100m
- Measures 173mm x 31mm (31mm head)
- Weight: 273 grams without batteries
- It can work with three AAA batteries
- USB charger
- Delivered with 18650 battery 2200mAh

## LED LIGHT

SAL02-FY

SAEWSAVE

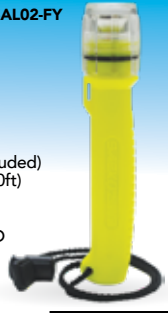

- High intensity
- 150 lumens
- Burn time 2.5 hrs
- Battery 2 x AA (not included)
- Waterproof to 60m (200ft)
- Easy to grip housing
- Simple rotary switch
- Bulb: CREE XPE-R5 LED
- Dimension: 16cm
- Lanyard (included)
- Available in yellow

## UNDERWATER KINETICS BEACON CYALUME LIGHT

TRIDENT

TDL27



- Length 22.86cm (9")
- Battery: 2 x AAA (included)
- Electric cyalume light, with backup glow in the dark plastic head and lanyard strap

## FUSION 260 LIGHT 260 LUMENS

TQVATEC

MSSFUS260



- Beam angle: 12-100° Zoom beam angle
- Dimensions 13.7 x 2.8cm & weight 147g
- Switch slide with multi function operation
- Battery choices: rechargeable CR14500 Li-ion with circuit protection or 2 x AA
- Burn time 2hrs
- Waterproof to 100m (328ft)

## UNDERWATER LASER POINTER

NEW

SAL-11SS-FY

SAEWSAVE



- High Visibility Red Laser Light Beam
- Lightweight Easy Grip Plastic Housing
- Easy to Use Magnetic Spring Switch
- Wrist Lanyard Included
- Waterproof to 60 meters
- 2 x AA Cell Batteries (not included)

## LED STROBE LIGHT

SAEWSAVE

SAL15A



- Waterproof: 60m (200ft)
- Battery: 3 x AA (not included)
- Strobe burn time: (72+ hours)
- Flash Rate: 36-40 times per minute
- Dimensions: (L x Dia.) 12cm x 5cm

## COMPACT TORCH 285 LUMENS

TQVATEC

MSSICOM-II



- Battery: 3 x AAA (not included)
- Burn time: 3hrs
- Variable Power: Full / 30% / strobe
- Depth rating 328ft / 100m
- Multi function magnetic side switch

## RECHARGEABLE BATTERY & CHARGER



Rech Battery 18650 Li-ion...M18650BAT  
Charger for Battery 18650 Li-ion...M18650CHR

## SEA SQUIRT TORCH

TQVATEC

MSSTORCH-HL1



- Battery: 4 x AAA (not included)
- Waterproof to 30m (100ft)
- Burn time: 6hrs
- 5 LED (1W), 25 lumens

## BATTERIES



MCR2BAT

MSSIT123

MAAA4

MAA4

Intova CR123 Lith. Battery 3V...MSSIT123  
Energizer MAX AA (4Pack)...MAAA4  
Energizer MAX AAA (4Pack)...MAAA4  
CR2 Battery, Lithium...MCR2BAT



## MAKO KNIFE TITANIUM / STAINLESS

SCUBAPRO



Stainless Steel

Titanium

Titanium...X32022  
Stainless Steel...X32023

- Features a conventional edge, line cutting notch, serrated edge for rope cutting, bottle opener & QR sheath with locking mechanism
- Titanium: extreme resistance to corrosion with durable edge
- Stainless Steel: excellent cutting edge & high resistance to rust
- Blade length: 8.5cm
- Overall length: 19cm

## WHITETIP BCD KNIFE

SCUBAPRO



X32002

- Compact stainless steel classic blade plus multi-use serrated edge
- Includes locking sheath & kit for BC/ hose attachment
- Blade length: 6.6cm
- Overall length: 14.7cm

## K6 KNIFE

SCUBAPRO



X320061

- Classic 15.5cm stainless steel blade with hammer in handle
- QR locking sheath

## SEA SNIP

SEA SNIP



SAS11N

- Cuts through line, net, rope, kelp & thin steel cable
- Works well in emergency situations where a knife might not
- New connector allows for mounting on BCD, weight belt or leg

## MESH CUTTER

SCUBAPRO



X32065

- Lanyard eyelet in handle for easy attachment
- Unique curved cutting edge design for pull cutting rather than push cutting, for better safety against accidents
- Contoured shackle spanner tool especially useful for boat divers
- Includes polyester case for safe storage & transport
- Overall length of cutter 7.5cm

## FOLDING KNIFE BLACK SS BLADE

SEA SNIP



Blue...S3118-B  
Green...S3118-G  
Black...S3118-K  
Orange...S3118-O  
Pink...S3118-Pi  
Purple...S3118-Pu  
Yellow...S3118-Y



- Blade: 304 stainless steel with black electro-plating
- Blade length: 9.1cm
- Corrosion resistant & non-reflective black blade
- Sharp tip with half serrated edge & line cutter
- Adjustable wrist lanyard
- Compact, lightweight & perfect for carrying on all your diving trips
- Colours: Black, Blue, Green, Pink, Purple, Orange, Yellow

## STAINLESS DIVE KNIFE

SEA SNIP



Blue...S3007-B  
Clear...S3007-C  
Green...S3007-G  
Black...S3007-K  
Yellow...S3007-Y



- Mount to belt, BCD strap or BCD pocket
- Sharp tip with serrated edge plus line cutter
- Colours: Black, Blue, Yellow, Green & Clear
- Blade length: 8cm

## FOLDING KNIFE

SEA SNIP



Titanium

Stainless Steel

Sheath

Stainless Steel...S3008  
Titanium...S3008T  
Nylon Sheath...SAH12

- Titanium: no rust, no magnetism, & no maintenance
- Stainless Steel: made of 301 SS, no rust, durable knife blade
- Versatile lanyard included
- Foldable; easy to carry in sheath or pocket
- Blade length: 10cm
- Optional sheath available

## TITANIUM / STAINLESS KNIFE

SEA SNIP



Titanium

Stainless Steel

Y K

Stainless Steel, Black...S3006-K  
Stainless Steel, Yellow...S3006-Y  
Titanium...S3006T

- Quality rubber strap with quickrelease buckle
- Quick-release locking plastic sheath
- Blade length: 14cm

## LINE CUTTER

SEA SNIP



SAC03

- Includes extra blades

## GALAXY MINI FOLDING KNIFE

AQUATEC



UKN100

- Material: 420 Stainless steel
- Over-all length: 95mm
- Blade length: 28mm
- Blade thickness: 2mm
- Weight: 21.5 gram

"Big enough to slice an apple & small enough to store in a small pocket. The serrated blade is made from surgical quality 420 stainless steel blade it's tough enough to handle years of use & abuse."

## RAPTOR KNIFE

AQUATEC



UKN170

- Material: 304 Stainless steel
- Over-all length: 170mm
- Blade length: 80mm
- Blade thickness: 4mm
- Weight: 75 gram
- Standard accessories: Sheath, Hose clip, BC mount

The AQUATEC Raptor Dive knife is perfect for diving. The advantages of this type of one-piece knife blade is its thin profile & less weight to make it more portable. The Raptor Scuba knife has an ergonomically shaped handle with a thin plastic insert to give the handle a very comfortable feel.

## T-REX KNIFE

AQUATEC



UKN200

- Material: 304 Stainless steel
- Over-all length: 200mm
- Handle length: 110mm
- Blade length: 90mm
- Blade thickness: 4mm
- Weight: 123 gram
- Standard accessories: Strap, Sheath, Hose clip, BC mount
- Straps: 1 x 470mm & 1 x 390mm

## STAINLESS KNIFE



S3009

- Sharp tip with serrated edge & line cutter
- Attaches permanently to BC or regulator hose
- Plastic sheath with hose mount included
- Blade length: 8cm



AQUATEC

**GALAXY MINI**



AQUATEC

**RAPTOR**



AQUATEC

**T-REX**

## SOFT POCKET WEIGHT BELTS



3 Pockets...DB5000  
4 Pockets...DB5001

## WEIGHT KEEPER



SAW06



SAW07



SS-928



SS-929B

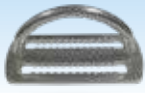

SS103



SAW03

Plastic Weight Keeper...SAW03  
Weightbelt Keeper, SS...SAW06  
Weightbelt Keeper, SS...SAW07  
Weightbelt Keeper w. D-Ring, SS...SS103  
D-Ring for Weightbelt, SS...SS-928  
Bent D-Ring for Weightbelt, SS...SS-929B

## WEIGHTBELT WEBBING



M1999

M1998



Webbing Roll (50m), Blue...M1998B  
Webbing Roll (50m), Yellow...M1998Y  
Webbing Roll (50m), Black...M1998K  
Webbing 1.4m, Blue...M1999-1.4B  
Webbing 1.4m, Yellow...M1999-1.4Y  
Webbing 1.4m, Black...M1999-1.4K  
Webbing 1m, Blue...M1999-1B  
Webbing 1m, Yellow...M1999-1Y  
Webbing 1m, Black...M1999-1K

## LEAD WEIGHTS



M6000-S

M6000-B

0.8kg Lead...M6000-S  
1.5kg Lead...M6000-B

New round shape:  
• Avoids equipment entanglement  
• More ergonomic fit

## WEIGHT BELT BUCKLES



UBK504



UBK 304

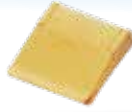

S4001

Plastic Buckles, Yellow...S4001-Y  
Plastic Buckles, Black...S4001-K  
SS Buckle - 2 Slots...UBK304  
SS Buckle - 3 Slots...UBK504

## WEIGHT BELT & BUCKLES



SAW02



X23.029.100



X23.030.100

M1999+Buc



B198



B1971

Scubapro Weightbelt w. Stainless Buckle - Black...X23.029.100  
Scubapro Weightbelt w. Nylon Buckle - Black...X23.030.100  
Saekodive Weighbelt w. Buckle - Blue...SAW02-B  
Saekodive Weighbelt w. Buckle - Yellow...SAW02-Y  
Saekodive Weighbelt w. Buckle - Black...SAW02-K  
Deep Blue Weighbelt w. Buckle 1.4m - Blue...M1999+Buc-B  
Deep Blue Weighbelt w. Buckle 1.4m - Yellow...M1999+Buc-Y  
Deep Blue Weighbelt w. Buckle 1.4m - Black...M1999+Buc-K  
Seac Rubber Weightbelt w. Stainless Buckle...B1971  
Seac Rubber Weightbelt w. Nylon Buckle...B198

## STICKERS & TAPE



M99997



TDS07



M99998



M99999

Oxygen Sticker for Tank...M99997  
O2 Clean Sticker...M99998  
EAN Tank Sticker...M99999  
Nitrox Valve Tape...TDS07

## SCUBA ALERT SIGNAL DEVICE



UAH150-01

## SCUBA HORN



• Duo Alert Standard Fitting



UAH380-01

## UNDERWATER RATTLER



Blue...DB6700-B  
Yellow...DB6700-Y  
Red...DB6700-R  
Black...DB6700-K



## TANK ANTI SLIP PAD



SAP0026

## CAM LOCK BUCKLE

• for Tank Strap



UCL201

## TANK MESH



Tank Mesh - Black...TA65-K  
Tank Mesh - Yellow...TA65-Y





## TANK BOOTS



TA56

SAT01

SAT02

SAT03

Rubber for LL63, LL80...SAT01  
 Rubber 18.4cm for 12L Steel Tank...SAT02  
 Rubber 20.3cm for 15L Steel Tank...SAT03  
 Plastic 17.5cm for LL50...TA56

## WHISTLE



SAW10

TD611

SAW11

TDA14

DBYWH001

High Pitch...SAW10  
 St&ard...SAW11  
 Wind Storm - Yellow...TD611-Y  
 Wind Storm - Orange...TD611-O  
 Wind Storm - Black...TD611-K  
 SOS Whistle...TDA14  
 SOS Whistle Pink...DBYWH001-Pi  
 SOS Whistle Yellow...DBYWH001-Y

## TANK BAND



X20.135.005

X23.073.010

UTB201

Scubapro Super Cinch Band...X20.135.005  
 Assy Super Cinch Plastic...X23.073.010  
 Aquatec Tank Band...UTB201

## VALVE CAPS



LVC-K

SA05

TA140

TRP66

Rubber...SA05  
 Cupped - Blue...TRP66-B  
 Cupped - Yellow...TRP66-Y  
 Cupped - Green...TRP66-G  
 Cupped - Black...TRP66-K  
 Thermo Pro...LVC-K  
 Delrin DIN plug...TA140

## TANK BANGER



SAT-29

TTA20

DBYP001

Tank Banger - Pink...TTA20-Pi  
 Tank Banger - Yellow...TTA20-Y  
 Tank Banger - Green...TTA20-G  
 Tank Banger - Black...TTA20-K  
 UW Pointer / Tank Banger...SAT-29  
 UW Pointer Aluminium Gray...DBYP001-Gy  
 UW Pointer Aluminium Pink...DBYP001-Pi  
 UW Pointer Aluminium White...DBYP001-W  
 UW Pointer Aluminium Yellow...DBYP001-Y

## SEAMATE INFLATABLE FLOAT

seac



B37001

- 420D polyester
- 7 D-rings under the keel for towing, anchoring, or fixing supplementary equipment
- 2 Handles on the bow to be used during handling
- 3 Independent air chambers to guarantee maximum safety
- 1 Alpha flag on the bow
- Dimensions: 85x60cm, Weight: 1.7kg

## LIFT BAG

seac



Lift Bag 100kg...B1900

## LIFE VEST

DEEPBLUE

Government approved  
 • Adult (fits: S-XXL)



DBJ03

DBJ02

## INFLATABLE SURFACE / RESCUE FLOAT

DEEPBLUE



DBYFB005

## SNORKELING VEST

DEEPBLUE



DBLSTRAP

DBL30

Junior - XS...DBL309-XS  
 Junior - S...DBL309-S  
 Adult - M...DBL302-M  
 Adult - L...DBL302-L  
 Adult - XL...DBL302-XL  
 Adult - XXL...DBL302-XXL  
 Crotch Strap XS-L...DBLSTRAP-A  
 Crotch Strap XL-XXL...DBLSTRAP-B

## POCKET RESCUE MARKER

DEEPBLUE



DBSM01

- 152cm x 14cm (60" x 5.5")
- Signal Orange / Neon Yellow combo
- Durable 210 denier nylon
- Securely retained by an elastic bungy cord

## RESCUE MARKER w. BAG

DEEPBLUE



DBSM02

Rescue Marker with Bag...DBSM02  
 Rescue Marker w/o Webbing...DBSM04

- 145cm(57") x 15.5cm (6")
- Signal Orange / Neon Yellow combo
- Durable 210 denier nylon fabric
- Webbing strap with marine grade stainless steel ring & snap hook
- Compact carry pouch for BCD attachment

## SAFETY BALLOON

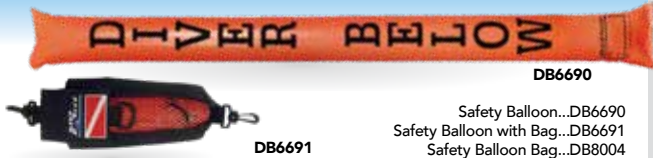

DB6690

Safety Balloon...DB6690  
Safety Balloon with Bag...DB6691  
Safety Balloon Bag...DB8004

DB6691

## SURVIVAL SAUSAGE

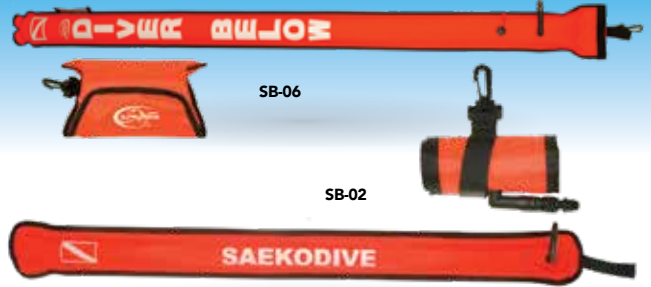

SB-06

SB-02

Survival Sausage with Pouch...SB-06  
Survival Sausage...SB-02

## MARKER BUOY



210D Nylon, 140x18cm...X40.312.001  
210D Nylon, 180x18cm...X40.316.000

X40.312.001  
X40.316.000

## DIVE MARKER



Yellow...DBYSMB1-FY  
Pink...DBYSMB1-Pi

- 180cm x 18cm (6ft)
- dump open end
- Available in Pink & Yellow

## WEBBING STRAP DEEP BLUE



- Webbing Strap for Rescue Marker, 5.5m

DBSM03

## LIFT BAG TRIDENT



Lift Bag 35kg w. Dump Valve...TLS15  
Lift Bag 75kg...TLS20

## DIVER'S FLOAT DEEP BLUE



DBS30

## MASK BOX



DBS1

## SLATE



SAW13

DBWR1

SAW15

TSL-19-Y

TSL05

TSL-13-Y

Slate w. Quick Connect 15x13cm...DBWR1  
Slate A4...SAW13  
Wrist Slate 3 Piece Multi Page...SAW15  
Slate & Graphite Pencil...TSL-19-Y  
Graphite Pencil...TSL-13-Y  
Quest Magnetic Slate...TSL05

## LANYARD

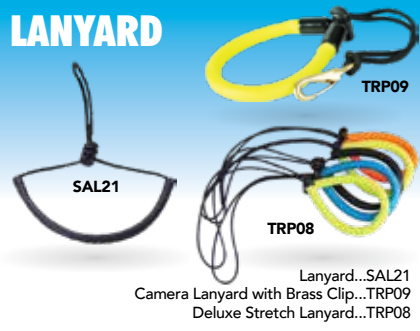

TRP09

SAL21

TRP08

Lanyard...SAL21  
Camera Lanyard with Brass Clip...TRP09  
Deluxe Stretch Lanyard...TRP08

## FISH ID SLATE

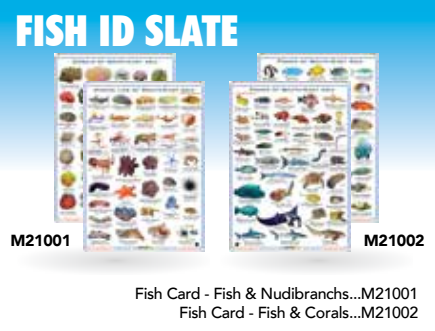

M21001

M21002

Fish Card - Fish & Nudibranchs...M21001  
Fish Card - Fish & Corals...M21002

## LOGBOOK



DBS9020

DBS9010

DBS9011

Log Pages for All Standard Binders...DBS9020  
Divers Log Book 15cm x 12cm...DBS9010  
Divers Log Book 14.5cm x 20.5cm...DBS9011

## LOGBINDER



"DIVE LOG"...DB8005  
Add Your Custom Logo...DB8005-C  
"DIVE NOW..."...DB8006  
"BORN TO DIVE"...DB8007

## RETRACTOR

SAR13A



SAR-03A

SAR13C  
K Y

SAR03C

Auto Lock Retractor 90cm...SAR-03A  
Retractor 3m...SAR03C  
40cm SS Line - 2 Clips...SAR13A  
40cm SS Line - Clip/Ring Black...SAR13C-K  
40cm SS Line - Clip/Ring Yellow...SAR13C-Y

## EQUIPMENT CONNECTORS



SAC01D

K Y

SAC01E

SAC01B

SAC01A

Equipment Connector...SAC01A  
Swivel Plastic Hook & Looped End...SAC01B  
Octopus Holder - Black...SAC01D-K  
Octopus Holder - Yellow...SAC01D-FY  
Fin Holder...SAC01E



## REEL COMPASS

Scubapro Multifunction Reel 80m...X40.122.000  
 Wreck Reel Auto Stop 85m...SAR05  
 Wreck Reel Auto Stop 45m...SAR15  
 Wreck Reel 45m...SAR14  
 Finger Reel 45m, black reel - white line...SAR06  
 Finger Reel 45m, orange reel - yellow line...SAR06-O/Y  
 Finger Reel 45m, yellow reel - orange line...SAR06-Y/O  
 Finger Reel 30m, black reel - white line...SAR16  
 Finger Reel 30m, orange reel - yellow line...SAR16-O/Y  
 Finger Reel 30m, yellow reel - orange line...SAR16-Y/O  
 Finger Reel 30m, Stainless reel - orange line...SAR16S-O  
 Finger Reel 30m, Stainless reel - yellow line...SAR16S-Y  
 Finger Reel 15m, black reel - white line...SAR26  
 Finger Reel 15m, orange reel - yellow line...SAR26-O/Y  
 Finger Reel 15m, yellow reel - orange line...SAR26-Y/O  
 Finger Reel 15m, Stainless reel - orange line...SAR26S-O  
 Finger Reel 15m, Stainless reel - yellow line...SAR26S-Y  
 Finger Reel Alu, 15m, Blue...DBYAR01-B  
 Finger Reel Alu, 15m, Pink...DBYAR01-Pi  
 Finger Reel Alu, 15m, Red...DBYAR01-R  
 Finger Reel Alu, 30m, Blue...DBYAR02-B  
 Finger Reel Alu, 30m, Pink...DBYAR02-Pi  
 Finger Reel Alu, 30m, Red...DBYAR02-R



X40.122.000



SAR05



SAR15



SAR06-



SAR14



SAR06



SAR16

SAR16-



SAR16S



SAR26



SAR26-



SAR26S



B R Pi

DBYAR01



B R Pi

DBYAR02

## COIL/NECKLACE



K Y

SAR07



SAR-0



SAR08



SAR09

Quick Release Coil Lanyard...SAR-0  
 Regulator Necklace - Black...SAR07-K  
 Regulator Necklace - Yellow...SAR07-Y  
 Quick Release Coil Lanyard - Black...SAR08-K  
 Quick Release Coil Lanyard - Blue...SAR08-B  
 Cable Wire Coil Lanyard...SAR09

## SNORKEL HOLDER



DBZ08-K

S1360



S1060



DBZ20

Plastic, Black...DBZ08-K  
 Snorkel, Holder...S1360  
 Plastic, Black...S1060  
 Silicone, Clear...DBZ20-C  
 Silicone, Black...DBZ20-K

## MASK STRAP RETAINER



DBZ01-K



SHLT



X26.021.002

Mask Strap ...SHLT  
 Mask Strap, Black...DBZ01-K  
 Quick Clip...X26.021.002

## BUCKLES



BS75106



BS75073



BS75075

BS75107 BS75074 BS75076  
 Male Buckle 25mm...BS75106  
 Female Buckle 25mm...BS75107  
 Male Buckle 40mm...BS75073  
 Female Buckle 40mm...BS75074  
 Male Buckle 50mm...BS75075  
 Female Buckle 50mm...BS75076

## MASK BUCKLES



S083



DBZ06-QR

K O



DBZ12-K

DBZ07

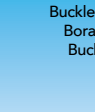

DBZ16

DBZ15



DBZ17



DBZ19

Mask Buckle - Black...S083-K  
 Mask Buckle - Clear...S083-C  
 Buckle Set BORA+ - Black, Orange...DBZ06-QR  
 Bora+ Roller Pin for Mask Buckle...DBZ19  
 Buckle & Housing Set (Fiji Mask)...DBZ07  
 Buckle Set (Fiji Mask)...DBZ12-K  
 Buckle (Bali Mask)...DBZ15  
 Buckle (Covert Mask)...DBZ17  
 Buckle (Mako Mask) 1 pcs...DBZ16

## NECK LATEX EYEWEAR STRAP



1pc. - Blue...TDA03-1-B  
 1pc. - Green...TDA03-1-G  
 1pc. - Blac/Grey...TDA03-1-K/G  
 1pc. - Orange...TDA03-1-O  
 1pc. - Pink...TDA03-1-P  
 6pc. - Yellow...TDA03-1-Y  
 6pc. - Blue...TDA03-6-B  
 6pc. - Green...TDA03-6-G  
 6pc. - Black...TDA03-6-K  
 6pc. - Orange...TDA03-6-O  
 6pc. - Pink...TDA03-6-P  
 6pc. - Yellow...TDA03-6-Y

Display w. 72 straps...TDA02-72

## EYEGLASS HOLDER STRAP



1pc. - Blue...TDA93-1-B  
 1pc. - Green...TDA93-1-G  
 1pc. - Black...TDA93-1-K  
 1pc. - Yellow...TDA93-1-Y



# MASK & GOGGLE STRAPS

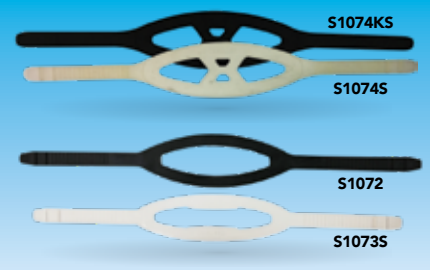
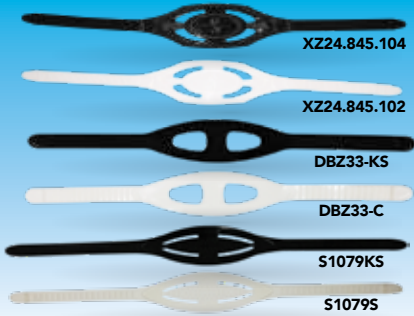

Velcro Strap w. Print, Black/Blue...DB6688-1-KB  
 Velcro Strap w. Print, Black/Black...DB6688-1-KK  
 Velcro Strap w. Print, Black/Red...DB6688-1-KR  
 Velcro Strap w. Print, Black/Yellow...DB6688-1-KY  
 Velcro Strap w/o Print, Black/Blue...DB6688-KB  
 Velcro Strap w/o Print, Black/Black...DB6688-KK  
 Velcro Strap w/o Print, Black/Red...DB6688-KR  
 Velcro Strap w/o Print, Black/Yellow...DB6688-KY  
 Neoprene w. Print, Black/Blue...DB6689-1-KB  
 Neoprene w. Print, Black/Black...DB6689-1-KK  
 Neoprene w. Print, Black/Yellow...DB6689-1-KY  
 Neoprene w/o Print, Black/Blue...DB6689-KB  
 Neoprene w/o Print, Black/Black...DB6689-KK  
 Neoprene w/o Print, Black/Yellow...DB6689-KY  
 Comfort - B,K, K/K, K/Y, P/Pu, Tq...X24.730.0x0

Mask Strap Cover 2.5mm Blk/Gry...X24.700.030  
 Mask Strap Cover 2.5mm Blk/Pur...X24.700.040  
 Mask Strap Cover 2.5mm Blk/Yel...X24.700.050  
 Mask Strap Cover 2.5mm Blk/Org...X24.700.060  
 Mask Strap Cover 2.5mm Blk/Blu...X24.700.070  
 Mask Strap Cover 2.5mm Blk/Wh...X24.700.080  
 Mask Strap Cover 2.5mm Blk/Blk...X24.700.090  
 Mask Strap Cover 2.5mm Blk/Pi...X24.700.100  
 Rubber - width 2cm...S1072  
 Silicone - width 2cm...S1073S  
 Black Silicone...S1074KS  
 Clear Silicone...S1074S  
 Clear Silicone, Spectra/Marin...XZ24.845.102  
 Black Silicone, Spectra/Marin...XZ24.845.104  
 22mm Clear Silicone, BORA...DBZ33-C  
 22mm Black Silicone, BORA...DBZ33-KS  
 Swimgoggle Black...S1079KS  
 Swimgoggle Clear...S1079S



## REEF HOOK



TDF82

## SWIVEL BOLT SNAP HOOK



SS225-92

## FIN STRAPS / BUCKLES



DBF770KIT



XZ25.071.005



XZ25.078.000



DBZ52



DBZ50



BZ513

S271



DBZ51

Strap Kit for Fin DBF770...DBF770KIT  
 Fin Buckle for DBF770...DBF770BUCKLE  
 Fin Strap for DBF770...DBF770STRAP  
 Quick Release Fin Buckle...S271  
 Propulsion Fin Buckle...BZ513  
 Twin Jet Strap Kit...XZ25.071.005  
 Twin Jet Max Strap Kit...XZ25.078.000  
 Fin Strap for Speed3...DBZ50  
 Fin Buckle Speed3...DBZ51  
 2 Buckles for Speed 3...DBZ52

## FIN SPRING STRAPS

**B K Y**  
 B730023 / B730024



S1875



S1775



XZ25.365

Sling Strap - Propulsion Fin, Small Blue...B730023-B  
 Sling Strap - Propulsion Fin, Small Black...B730023-K  
 Sling Strap - Propulsion Fin, Small Yellow...B730023-Y  
 Sling Strap - Propulsion Fin, Regular Blue...B730024-B  
 Sling Strap - Propulsion Fin, Regular Black...B730024-K  
 Sling Strap - Propulsion Fin, Regular Yellow...B730024-Y  
 Spring Strap w. Buck. S, Set...S1775-S  
 Spring Strap w. Buck. M, Set...S1775-M  
 Spring Strap w. Buck. L, Set...S1775-L  
 Spring Strap w. Buck. XL, Set...S1775-XL  
 Spring Strap size S (Set)...S1875-S  
 Spring Strap size M (Set)...S1875-M  
 Spring Strap size L (Set)...S1875-L  
 Spring Strap size XL (Set)...S1875-XL  
 Spring Heel Straps - Jet Fin M...XZ25.365.305  
 Spring Heel Straps - Jet Fin L...XZ25.365.405  
 Spring Heel Straps - Jet Fin XL...XZ25.365.505  
 Spring Heel Straps-Jet Fin XXL...XZ25.365.605

## FIN STRAPS



BZ07001-2



S1075



SA004A

Saekodive Fin Strap / 1 Piece...S1075  
 Seac Sprint Fin Strap, XXS/S...BZ07001  
 Seac Sprint Fin Strap, S/XL...BZ07002  
 Saekodive Jet Fin Strap...SA004A

## KNIFE STRAP



S1077-2



S1077



TKN02

Quick Release Knife Strap...S1077-2  
 Rubber Knife Strap...S1077  
 Knife Strap with Spring...TKN02

## MOUTHPIECE HOLDER

• Hook, 92mm



SAM-050

## ALUMINIUM SNAP HOOK



SAS-12DF-8 SAS-12DF-6  
Snap Hook 50mm...SAS-12DF-5  
Snap Hook 60mm...SAS-12DF-6  
Snap Hook 70mm...SAS-12DF-7  
Snap Hook 80mm...SAS-12DF-8

## HOSE CLIP/CLAMP



DBYPC001 SAH01 SAH09 UHH07  
Ergonomic Swivel Hose Clip...SAH23  
Double Hose Clamp - Black...SAH01-K  
Double Hose Clamp - Yellow...SAH01-Y  
Triple Hose Clamp - Blue...SAH09-B  
Triple Hose Clamp - Black...SAH09-K  
Triple Hose Clamp - Yellow...SAH09-Y  
Double Hose Clip - Green...UHH07-K  
Double Hose Clip - Black...UHH07-K  
Ergonomic Swivel Hose Clip, Pi...DBYPC001-Pi  
Ergonomic Swivel Hose Clip, W...DBYPC001-W  
Ergonomic Swivel Hose Clip, Y...DBYPC001-Y

## BRASS CLIPS



S4002-120 S4003-120 S4003-88 S4002-95  
Brass Clip (S) 95mm...S4002-95  
Brass Clip (S) 88mm...S4003-88  
Brass Clip (L) 120mm...S4003-120  
Brass Clip (L) 120mm...S4002-120

## DOUBLE ENDED SNAP HOOK



SS161-90 SS162-100 SS163-115  
Hook, 90mm...SS161-90  
Hook, 100mm...SS162-100  
Hook, 115mm...SS163-115

## STAINLESS SNAP HOOK



S2450-80 SS243-6 SS243-8  
Stainless Steel Snap Hook...S2450-80  
Stainless Steel 60mm Hook...SS243-6  
Stainless Steel 80mm Hook...SS243-8

## OCTOPUS HOLDER / RETAINER



SAC06 SAC06A XZ01.097.134 SAM-02  
Octopus Holder - Green...SAM-02-G  
Octopus Holder - Yellow...SAM-02-Y  
Magnetic Octopus Holder...SAC06  
Non-Magnetic Octopus Holder...SAC06A  
Octopus Retainer...XZ01.097.134

## GEAR HANGER



Universal - Blue...SAH06-B  
Universal - Black...SAH06-K  
Universal - Yellow...SAH06-Y

## TANK BACK PACK COMPLETE



UTP201

## VALVE DUST CAP



XZ10.101 SAD01 SAD02 BS2011 TA143  
DIN Protection Cap...BS2011  
Delrin DIN Cap 200 Bar...TA143  
Dust Cap DIN...XZ10.101.211  
Dust Cap INT...XZ10.101.212  
Rubber Cap...SAD01  
Plastic Cap...SAD02

## REAR WEIGHT HOLDER



B769

## SHOULDER DUMP VALVE

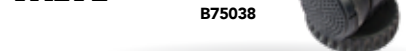

B75038

## SWIVEL



DBT30019 XZ06.203.548 SAS-16 F1000V5593  
Seakodive Swivel - 360°...SAS-16  
Uwatec Swivel w. O-Rings...XZ06.203.548  
Suunto HP Swivel...F1000V5593  
HP Swivel Disc & O-Rings...DBT30019

## DIN CONVERSION

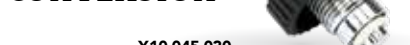

X10.045.030

## RETAINER

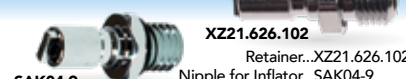

SAK04-9 XZ21.626.102  
Retainer...XZ21.626.102  
Nipple for Inflator...SAK04-9



## SCHRADER VALVE

XZ21.562.106



MA59

Scubapro...XZ21.562.106  
For Most Inflators...MA59

## DIN ADAPTOR



SAA08



WMDCH-DIN



SDY-1



SDY-3F#1

300BAR Din To Yoke...WMDCH-DIN  
DIN Adaptor Saekodive...SDY-1  
Yoke Screw for DIN Adaptor...SDY-3F#1  
Pin Index to DIN Adaptor...SAA08

## OVERPRESSURE VALVES



XZ21.200.003



UOV1811



B55006

Seac...B55006  
Pull Ball...UOV1811  
Kit Overpressure Valve...XZ21.200.003

## CORRUGATED HOSES



B75020

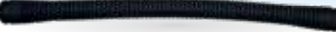

X01.030.114

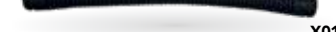

X01.030.113

Seac Corrugated Hose...B75020  
Scubapro 14", Classic Plus/Sport...X01.030.113  
Scubapro 16", Classic Plus/Sport...X01.030.114

## REGULATOR ADAPTER / SWIVEL



WMDAB-05



WMDAB-07



WMDAB-12



WMDUA-8



WMDUA-1



WMDUA-4



WMDUA-7



WMDUA-16



WMDUA-23



WMDUA-9

LP 90° Adapter...WMDAB-05  
LP 110° Adapter...WMDAB-07  
9/16" M to 3/8" F...WMDUA-1  
3/8" M to 1/2" F...WMDUA-4  
1/2" M to 3/8" F...WMDUA-7  
LP Swivel 90°...WMDUA-8  
HP Splitter...WMDUA-9  
9/16" Y-Adapter FFxM...WMDAB-12  
HP Swivel 90°...WMDUA-16  
360° LP Adapter...WMDUA-23

## HIGH PRESSURE HOSES



XZ01.344.005

Scubapro hose 80cm...X01.044.031  
Scubapro Hose Quick Connector...XZ01.334.005  
Hose (made in Italy) 31.5"/80cm, dia 10.8mm...DBT30016-01  
Hose (made in Italy) 6"/15cm, dia 12.5mm...DBT30017-01

## COMPLETE INFLATOR SYSTEM



B75040

## LOW PRESSURE HOSES



SAH-03



SAT19



XZ21.626.013



SAT20

Regulator hose 75cm...SAH-03-K-75  
Octopus hose 95cm, Black...SAH-03-K-95  
Octopus hose 95cm, Yellow...SAH-03-Y-95  
Regulator hose 210cm...SAH-03-K-210  
LP inflator hose 65cm...SAH-04-K-65  
Scubapro hose 2nd Stage 65cm...XZ01.310.026  
Scubapro hose 2nd Stage 75cm...XZ01.309.035  
Scubapro octopus hose 100cm...XZ01.310.040  
LP inflator hose air 2, 64cm, Black...LUP350-02  
Adaptor, Inflator quick connector...XZ21.626.013  
Tire Inflator...SAT19  
Tire Inflator...SAT20

## HOSE PROTECTOR



S4004

XZ11.700.0x0

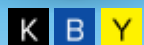

DBT30018



M20070-07

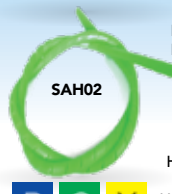

SAH02



Plastic Wrap - Blue...SAH02-B  
Plastic Wrap - Yellow...SAH02-Y  
Plastic Wrap - Green...SAH02-G  
Scubapro - Black...XZ11.700.010  
Scubapro - Yellow...XZ11.700.030  
Scubapro - Green...XZ11.700.050  
Deep Blue - Black...M20070-07-K  
Deep Blue - Yellow...M20070-07-Y  
Hose Protector Black...S4004-K  
Hose Protector Blue...S4004-B  
Hose Protector Yellow...S4004-Y  
Hose Protector - Black...DBT30018

## MOUTHPIECE & HOSE PROTECTOR

SCUBAPRO



**MP & Hose Protector Kit:**  
Hydros Blue...XZ01.040.330  
Hydros Yellow...XZ01.040.360  
Hydros Pink...XZ01.040.370  
Hydros Orange...XZ01.040.390  
White...XZ01.040.080  
Purple...XZ01.040.019

**Hose protector:**  
Black...XZ11.700.010  
Purple...XZ11.700.019  
Yellow...XZ11.700.030  
Green...XZ11.700.050  
Hydros Blue...XZ11.700.223  
Hydros Yellow...XZ11.700.225  
Hydros Orange...XZ11.700.226  
Hydros Pink...XZ11.700.227



## MOUTHPIECE

Mouthpiece Black with dots...DBZ1463KS  
 Mouthpiece Clear with dots...DBZ1463S  
 Rubber Mouthpiece...S1063  
 Silicone with bridge (Clear)...S1163S  
 Silicone with bridge (Black)...S1163KS  
 Small Silicone Mouthpiece...S1363S  
 Long Bite Silicone (Clear)...S1563S  
 Long Bite Silicone (Black)...S1563KS  
 Silicone Black/Yellow...S1663KS-Y  
 Silicone Black/Orange...S1663KS-O  
 Reshapeable Mouthpiece - Black...S1763KS-K  
 Reshapeable Mouthpiece - Clear...S1763S-C  
 Moldable M'piece, Silicone-BT...S1863-BT  
 Moldable M'piece, Silicone-PIT...S1863-PIT  
 Moldable M'piece, Silicone-W...S1863-W  
 Moldable M'piece, Silicone-YT...S1863-YT  
 Mouthpiece Vinyl...XZ01.040.131  
 Mouthpiece Black Silicone...XZ01.040.141  
 Mouthpiece with Clip...XZ01.040.051  
 Reusable Clip...XZ01.040.025  
 Reusable Clip Light...XZ01.040.026  
 Mouthpiece Air2 4th...XZ01.040.133  
 Mouthpiece Escape...XZ01.040.705



XZ01.040.025



XZ01.040.026



DBZ1463KS



DBZ1463S



S1063



S1163KS



S1163S



S1363S



S1563KS



S1563S



S1663KS

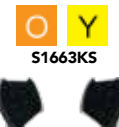

XZ01.040.133



S1763

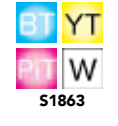

S1863



XZ01.040.120



XZ01.040.705

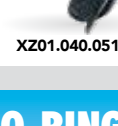

XZ01.040.051



XZ01.040.131

## O-RING KIT

Mini O-ring Kit 10pcs...TD601  
 "Save a Dive" 40pcs + Silicone...TD602  
 Mini Viton Kit 10pcs...TD603  
 Viton O-ring Kit 20pcs...TD604



TD601



TD602



TD603



TD604

## SNORKEL MOUTHPIECE

Mouthpiece for J Snorkel, Black...DBZ02-K  
 Mouthpiece for J Snorkel, Clear...DBZ03-C  
 Mouthpiece for Manta/Sharky, PVC Clear & Black...DBZ04  
 Mouthpiece for Manta/Sharky, Clear Silicone...DBZ05-C  
 Mouthpiece for COVERT Snorkel, Silicone, Black...DBZ09-K  
 PurgeValve Manta, Mako, Stingray...DBZ13  
 Mouthpiece S1052 Silicone...S1052MS  
 Mouthpiece S1052 PVC...S1052MP  
 Mouthpiece S1052 Rubber...S1052MR  
 Snorkel Valve for S1156S...S1055  
 Silicone Mouthpiece for 1156...S1156MS  
 PVC Mouthpiece for 1156...S1156MP



DBZ02-K



DBZ04-K



DBZ04-C

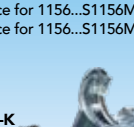

S1156MS/MP



S1052MS/MP



S1052MR



S1055



DBZ09-K



DBZ13



DBZ205-C



DBZ205-C

## POWER INFLATOR



SAK04PIN



B75039



B77454



X21.610.000



X21.600.100



UPI208



UPI201



Scubapro NEW Power Inflator w. BPI Hose...X21.610.000



Scubapro Power Inflator w. BPI Hose...X21.600.100



Seac Piston Power Inflator...B77454



Seac Power Inflator...B75039

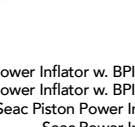

Power Inflator...UPI201

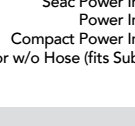

Compact Power Inflator...UPI208

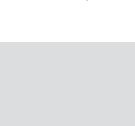

Inflator w/o Hose (fits Subgear)...SAK04PIN

## LUBRICANTS



TLP25



TSA66

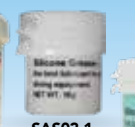

SAS03-1



SAS01



TLP27



TNT72

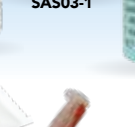

DBSY1



TNT79



TNT90

## LIQUIDS & CLEANERS

Mask Cleaner 1oz...TLP75  
 Ear Drops...TFA20



TLP75



TFA20

## DEFOG

Defog 2oz...TLP81  
 Silicone Spray 2oz...TLP80  
 Fog off...TLP85



TLP85



TLP81



TLP80

## NEOPRENE GLUE



SAS12K

## KEY RING STAINLESS



SAR-02

## TANK KEY RING

Tank Key Ring...SAD07  
 Alu Tank w. Brass Pick & O-rings...SAD08



SAD07



SAD08

## VELCRO BAND



TDA69

## AIRWAY FOR LITTLE ANNIE



D020300

Disposable non-rebreathing airways with one-way valve should be changed after each class for maximum instructor convenience & student safety.

## LITTLE ANNE

DA1016



The Little Anne manikin is a realistic, inexpensive, lightweight, adult CPR trainer that offers all the essential features. Designed with both the user & instructor in mind. Includes 2 economical, disposable airways for quick & easy cleanup & 2 removable, reusable faces.

## KEY RING CPR MASK



SAR20

CPR pocket size resuscitator mask (S) with key ring

## CPR RESCUE MASK

SAR10



## EMERGENCY OXYGEN FIELD KIT

Includes:

- 1 x Oxygen pressure reducer with 2 x demand valve connections, 1 x adjustable 0-25l/min constant flow connection with miniature pressure gauge
- 1 x Demand valve with connection hose LP
- 1 x Adaptor Oxygen Bull nose (CGA540) to DIN (G5/8)
- 1 x Adaptor PIN Index to DIN (G5/8)
- 1 x Pocket mask for demand valve & adaptor
- 1 x Constant flow mask with reservoir, LP hose & coupling
- 1 x transport bag



MO2RegW



MO2Reg1



MO2KIT-1

Oxygen Field Kit...MO2KIT-1  
Oxygen Regulator, Pin-index, 0-25LPM...MO2Reg1  
Brass/Viton Washer for Oxy Reg...MO2RegW

## PORTABLE OXYGEN FIRST AID KIT

Includes:

- Oxygen 2 pin index regulator
- 3 litre oxygen tank
- Non rebreather mask
- 2 pin index fill adaptor



MO2FILL



MO2KIT-2

Oxygen First Aid Kit...MO2KIT-2  
Pin-Index - CGA 540 Adaptor...MO2FILL

## NON REBREATHER MASK

DA1015



This disposable mask provides oxygen for breathing divers who cannot tolerate demand valve oxygen regulators or when you have 2 divers who need emergency oxygen.

## MAXO2 + OXYGEN ANALYZER

- MaxO2@+A Oxygen Analyzer (incl. Sensor & OxyKnob)
- Comfortable handheld design
- Impact resistant & drip proof
- Large 3-digit LCD display
- Long battery life (approx. 5,000hrs)

MR217P52



MR217P42

MaxO2@+A Oxygen Analyzer (Internal Sensor)...MR217P42  
MaxO2@+AE Oxygen Analyzer (External Sensor)...MR217P52

## OXYGEN SENSOR FOR MAXO2 ANALYZER

for MaxO2@+A...MR125P01-011  
for MaxO2@+AE...MR125P03-004



MR125P01-011

MR125P03-004

## MAX O2 ACCESSORIES

MR218P19



MRP11P28



OX-SNSR

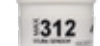

MR207P17



XA11.452

OxyKnob...MR218P19  
BC Adapter Maxtec...MRP11P28  
Barbed Adapter w. Tubing...MR207P17  
OMS O2 Fuel Cell...OX-SNSR  
Oxy Spy Sensor Only...XA11.452

## RESCUE TAPE



1" Rescue Tape - Clear...TFA64-CL  
1" Rescue Tape - Black...TFA64-K  
1" Rescue Tape - Orange...TFA64-O  
1" Rescue Tape - Red...TFA64-R

## MARKER

Brite Mark Paint - Black...TPA60-K  
Brite Mark Paint - Red...TPA60-R  
Brite Mark Paint - White...TPA60-W  
Brite Mark Paint - Yellow...TPA60-Y





# WORKSHOP TOOLS



SAP-0002A



SAP-0001



XZ43.300.998



XZ43.018.000



XZ43.300.225



XZ43.403.000  
XZ43.403.001



SAA01



XZ41.496.101



XZ43.191.107



SAA06



XZ43.300.107



TS105



XZ43.300.002  
XZ43.300.003



MSOCKET-6MM



M51



TSA58



DBBRTOOL



XZ43.040.000



TSA99



S7402

- O-ring Pick Brass...XZ43.300.017
- O-Ring Tool Kit + Silicone...TDA79
- Nut Driver 1/4"...XZ43.300.002
- Nut Driver 5.5mm...XZ43.300.003
- Tank Valve Knob Removal Tool...TSA99
- Divers Deluxe Tool Kit...TS105
- Multi Tools Stainless Steel with 12 Tools...S7402
- Multi Tools Stainless Steel with 9 Tools...S7407
- Hose Protector Installation Tool...TSA05
- Hose Protector Installation Tool...XZ43.018.000
- Torque Wrench 5 - 35N...XZ43.300.998
- Air Nozzle Rubber...SAA06
- Air Nozzle Stainless Steel...SAA01
- Stainless Multipurpose Tool...DBBRTOOL
- Adjusting Tool 2nd Stage...SAP-0002A
- Intermediate Pressure Gauge...SAP-0001
- 6mm Extension Drive...MSOCKET-6MM
- Cover Tool R395 / S600 / Air2...XZ43.403.000
- Covers Tool C200, C300 Insert...XZ43.403.001
- HP-Seat Tool MK2...XZ43.300.210
- Flow Vane Tool - 2nd Stages...XZ43.300.225
- Scubapro Universal Tool...XZ43.040.000
- 1st Stage Holding Tool...M51
- Plastic Syringe...XZ41.496.101
- Schrader Valve Tool...TSA58
- Yoke Nut Socket...XZ43.191.107
- O-ring Pick Plastic / Stainless Steel...XZ43.300.107

XZ43.300.017



TDA79



S7407





# WORKSHOP TOOLS



V1117



SAP-0003A1



QN1315



QN4101



M2310



SAP0004A



SAP-0003A



TSA83



WMDOW-03



XZ43.404.001P



WMDMT-610



M99 / M97

- Oil Filled Pressure Gauge Stainless...V1117
- Gauge for HP Checker...SAP-0003A1
- Gauge Bauer 315bar...QN1315
- Gauge Bauer 400bar...QN4101
- Magnehelic Mouthpiece...XZ43.404.001P
- Analogue Gauge 5-0-5" WC...M2310
- Tank Pressure Checker INT...SAP-0003A
- Tank pressure checker DIN 300bar...SAP0004A
- Cable Tie 3.5x150mm, Pack of 100pcs...M99
- Cable Tie 4.8x250mm, Pack of 100pcs...M97
- Cable Tie Installation Gun...TSA83
- Inline Adjust Tool W. Gauge...WMDMT-610

## ULTRASONIC CLEANING DEVICE

- Ultrasonic frequency: 40,000 Hz
- Tank material: stainless steel SUS304
- Shell material: SUS304
- Tank capacity: 4.5 L
- Ultrasonic power: 180 W, 3 transducers
- Heating power: 200 W
- Tank size: 300 x 150 x 100 mm (L x W x H)



MJP030

## ULTRASONIC SOLUTION

- Mixing ratio 100g powder to 2L water
- Powder dissolves in water
- 500g or 1000g Container



Ultrasonic Solution (500 gram)...TSA65-500  
Ultrasonic Solution (1 Kg)...TSA65-1000

## DISINFECTANT SOLUTION for EQUIPMENT

- Mixing ratio 1kg powder to 20L water
- Powder dissolves in water
- 3kg or 5kg Container



Cleaning Solution (3 Kg)...DBESAFE-3  
Cleaning Solution (5 Kg)...DBESAFE-5



# THERMO & XS SCUBA VALVE PARTS

- LVK01-AIR Overhaul Kit Thermo K-Valves (Air)  
(MA015-U, L35069-K, L5270-16N, L3100-9-U, L5270-5N)
- LVK01-EAN Overhaul Kit Thermo INT/DIN Valves (Nitrox)  
(MA015V-U, L35069-K, L5270-16N, L3100-9E-U, L5270-5N)
- L3990-5000N 1. Safety Assembly (3,000 psi), EAN ready
- TR014 2. O-Ring Valve Outlet
- TR014S 2. O-Ring Valve Outlet Polyurethane
- LGR014P9 2. O-Ring Valve Outlet Viton
- MA015 3. O-Ring Tank Neck
- MA015V 3. Viton O-Ring Tank Neck
- L5270-15N 4. Dip Tube plated (VP04 Pre 10/09), EAN ready
- LVX04 4. Dip Tube plated (VX04 Post 10/09), EAN ready
- L35069-K 5. HP-Seat, O2 ready
- L5270-16N 6a. Bonnet Gasket, EAN ready
- LVX17-E 6b. O-Ring EPDM (Bonnet)XS Scuba
- L5270-8PN 7. Stem EAN ready
- L3100-9 8. O-Ring for Stem, Thermo Valve, AIR
- L3100-9E 8. Viton O-Ring Stem Thermo
- L5270-5N 9. Stem Packing, Ean ready
- L5270-4PN 10a. Bonnet Nut, EAN ready
- LVX10 10b. Bonnet Nut, XS Scuba
- L5240-10 11. Handwheel Washer, EAN ready
- L5240-6A 12. Handwheel - Black
- L5270-6N 12. Handwheel - Green
- L5240-9 13. Spring EAN ready
- L5203-7P 14. Handwheel Nut, EAN ready
- LVP15V 15. Viton O-Ring (Thick) Outlet DIN/INT - Thermo Pro Valve
- MP31B 15. O-Ring (Thick) Outlet DIN/INT - Thermo Pro Valve
- L5440-23 16. DIN / K Insert w. Viton O-rings, EAN ready
- LVX22 17. Safety Handwheel only - black XS Scuba
- LVX20 18. Safety Hand Wheel insert Red & Green XS Scuba

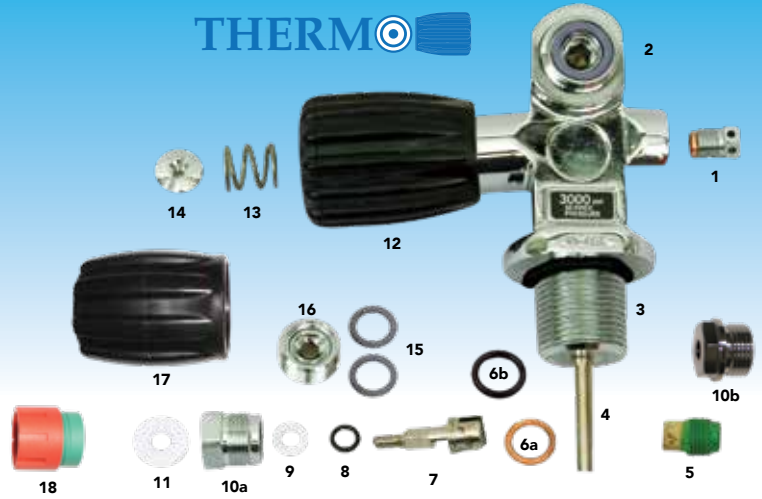

# SMT VALVE PARTS

- LGVP00-AIR Service Kit SMT Valve  
(LGVP07/09/45, MA015-U, 2 x LGR010E-U, LGRM075E-U)
- LCV04-A 1. Complete Stem Assembly Incl. 7, 2x8, 9, 10
- LGVP45 4. HP-Seat SMT Valve, Oxygen ready
- LGVP07 7. Gasket
- LGR010E 8.O-Ring Stem
- LGVP09 9. Backup Ring
- LGRM075E-U 10. O-Ring Bonnet
- LGVP20 20. Handwheel Elastomer
- LGVP99 20. Handwheel Green (Nitrox)
- LGVP22 22. Handwheel Nut
- LCV26-30 25.&26. Safety Plug & Burst Disk 3,000 psi (5,000 burst)
- LGVP28 28. Dip Tube
- 2. See Thermo Valve Parts above
- 3. See Thermo Valve Parts above

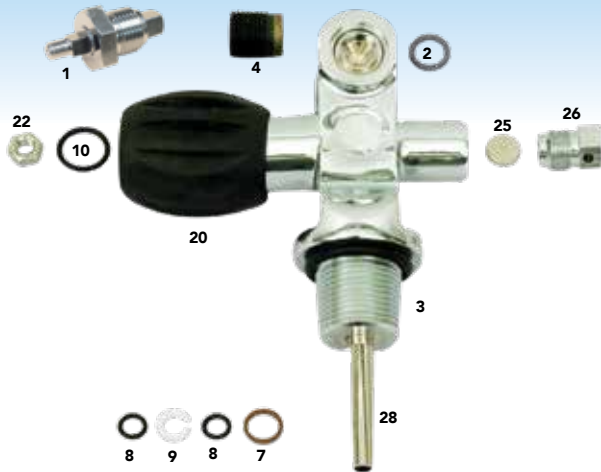

# SHERWOOD VALVE PARTS

- L350620-AIR Overhaul Kit Sherwood Valve  
(MA015-U, L350067, L350069, L350610, L350618)
- L5203-7P 1. Handwheel Nut, EAN ready
- L350611A 11. Spring - Sherwood valve
- L60002 13. Handwheel Sherwood - Black
- L1413 4. Handwheel Washer, Sherwood valve
- L5270-4PN 5. Bonnet Nut, EAN ready
- L350610 6. Copper Gasket
- L35067 7. Thick Teflon Ring (new style seal)
- L350618 8. Thin Teflon Ring (new style seal)
- L9350612 9. Stem/Spindle
- L35069 10. Plug Assembly HP-Seat
- L35069-K 10. Plug Assembly HP-Seat O2 ready
- L400012048 12. Safety Plug Assembly 3,000 psi
- 2. See Thermo Valve Parts above
- 3. See Thermo Valve Parts above





# DEEP BLUE VALVE PARTS THERMO COMPATIBLE



- DBMV01-AIR Overhaul Kit for DEEP BLUE valves (Air) (MA015, DBMV10BKA, DBMVG061C, L3100-9, DBMVG07-2T)
- DBMV01-EAN Overhaul Kit for DEEP BLUE valves (Nitrox) (MA015V, DBMV10BKA, DBMVG061C, L3100-9E, DBMVG07-2T)
- DBMVA5000 TR014 1. Safety Assembly (3,000 psi), EAN ready
- TR014S 2. O-Ring K Valve Outlet (NBR)
- LGR014P9 MA015 2. O-Ring K Valve Outlet (Polyurethane)
- MA015V 2. Viton O-Ring Outlet
- DBMVT15-2 3. O-Ring Tank Neck
- DBMVT15-3 3. Viton O-Ring Tank Neck
- DBMV10BKA 4. Dip Tube plated (Pre 10/09), EAN ready
- DBMVG061C 4. Dip Tube plated (Post 10/09), EAN ready
- DBMVG09-3BP 5. Deep Blue HP Seat Assembly, O2 ready
- L3100-9 6. Bonnet Gasket, Copper, EAN ready
- L3100-9E 7. Stem EAN ready
- DBMVG07-2T 8. O-Ring for Stem, DeepBlue & ThermoValve, AIR
- DBMV05-2BP 8. Viton O-Ring for Stem, DeepBlue & ThermoValve
- DBMWW04-1 9. Stem Packing, EAN ready
- DBMWW03-2 10. Bonnet Nut, EAN ready
- DBMVP02-3 11. Handwheel Washer, EAN ready
- DBMV01BP 12. Handwheel - Black
- LVP15V 13. Spring EAN ready
- MP31B 14. Handwheel Nut, EAN ready
- DBMVDP13 15. Viton O-Ring (Thick) Outlet DIN/INT -Thermo Pro Valve
- 15. O-Ring (Thick) Outlet DIN/INT - Thermo Pro Valve
- 16. Deep Blue DIN / K Insert w. Viton O-rings, EAN ready



## K VALVE INT

- EAN ready
- 3,000 psi / 207 bar pressure
- Thermo compatible parts



DBMV4030

## PRO VALVE INT / DIN

- EAN ready
- 3,000 psi / 207 bar pressure
- Thermo compatible parts



DBMV4035

## TANK VALVE

- Thermo Valve INT...LVCA4030
- Thermo Pro Valve...LVCA4035
- Thermo Pro H Adapter Left...LVH200L-N
- Thermo Pro H Adapter Right...LVH200R-N
- DIN / K Insert w. Viton O-rings, EAN ready...L5440-23



L5440-23



DIN/INT AIR/EAN Nitrox Ready



LVH200R-N



LVH200L-N

## MODULAR VALVES



- 1. Deep Blue Modular Valve, Left Hand...DBMV-1L
- 2. Deep Blue Modular Valve, Right Hand...DBMV-1R
- 3. Deep Blue Modular Valve, Centre...DBMV-CTR
- Deep Blue Twin Isolation Valve Complete Set...DBMV-SET

DBMV-SET

## THERMO TWIN ISOLATION VALVES



- Thermo Twin Isolation...LVCA5420
- 1. Modular Valve Left Hand...LVCA8044LH
- 2. Modular Valve Right Hand...LVCA8044RH
- 3. Modular Valve Centre...LVCA8033CTR

LVCA5420



# ALUMINIUM TANK



Cylinder	Service Pressure		Capacity Air		Outside Diameter		Overall Length		Empty Weight		Min. Internal Volume	
Item No.	psi	bar	cu.ft.	litres	In.	mm	In.	mm	lbs	kg.	cu.in	ltrs
LL19	3000	207	19.9	563.6	4.38	111.13	18.6	471.4	8.2	3.7	175	2.9
LL40	3000	207	40.0	1132.8	5.30	133.40	24.6	628.7	15.3	6.9	350	5.7
LL50	3000	207	48.4	1370.7	6.89	175.01	19.0	482.6	21.2	9.6	424	6.9
LL63	3000	207	63.0	1784.2	7.25	184.15	21.9	555.0	26.7	12.1	552	9.0
LL80	3000	207	77.4	2192.0	7.25	184.15	26.1	661.9	31.4	14.2	678	11.1
LL100	3300	224	98.8	2798.0	8.00	203.20	26.2	665.7	41.0	18.6	804	13.2

# TWIN TANK BANDS



SBP-65



- Suitable for 7.25" Diameter Tanks
- Made from 316 Stainless Steel
- Smoothed Edges to Prevent Tank Damage
- High Tensile Strength and Corrosion Resistant
- 2.5" Wide
- Screw Sets Included

# ACTIVATED CARBON



M100-C

500g carbon...M100-C  
1kg Molec. Sieve & 500g Carbon...M100-Pack

# MINERAL OIL



MM01



MM03



MM05

Mineral Oil - 1L...MM01  
Mineral Oil - 3L...MM03  
Mineral Oil - 5L...MM05

# SYNTHETIC OIL



QN28355-1

QN28355-5

Synthetic Oil - 1L...QN28355-1  
Synthetic Oil - 3L...QN28355-3  
Synthetic Oil - 5L...QN28355-5

# FELT FOR FILTERS

PER SQ. METER...M105  
Felt for Coltri 40mm (20pcs)...M106  
BAUER P41 (5set)...M107  
BAUER P31 (5set)...M108  
LW 260-450 (5set)...M109  
LW 160-245 (5set)...M110  
BAUER P21 (5set)...M111



M109



M111

# MOLECULAR SIEVE

1000g



M100-S

# FILLING HOSE HP



Filling Hose HP 1m SS...M112SS  
Filling Hose HP 1.5m SS...M113SS  
Filling Hose HP 2m SS...M114SS  
Filling Hose HP 3m SS...M115SS  
Filling Hose HP 4m SS...M117SS  
Filling Hose HP 5m SS...M118SS  
Bauer-Filling Hose 1m...QN2817  
Bauer-Filling Hose 2m...QN2818  
Flexible O2 Hose R1/4" SS...MFLEX-O2-SS

# FILLING VALVE

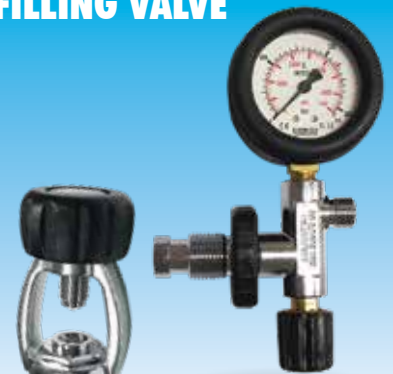

Q071343



SDY-3



Q071744

Filling Valve PN200 - No gauge...Q071744  
Filling valve PN300 - No gauge...Q071743  
Filling valve PN200 w gauge...Q071343  
Filling valve PN300 w gauge...Q071344  
Filling Valve w/o gauge...SDY-3

## AIR STORAGE & PURIFICATION B-KOOL



The B-KOOL refrigeration dryer from BAUER considerably reduces the running costs of the compressor whilst protecting the environment at the same time.

At locations with particularly high ambient temperatures, B-KOOL assures a remarkably longer life time of the filter cartridge. You will benefit from a lower cost of purchase & storage of filter cartridges, a longer uninterrupted compressor operation & a lower consumption of filter cartridges.

- 200 - 680 l/min
- 100 - 350bar
- Up to 11 times longer life for your filter cartridges!
- Environmentally sound
- Integrated or as stand-alone version
- Easy to retrofit

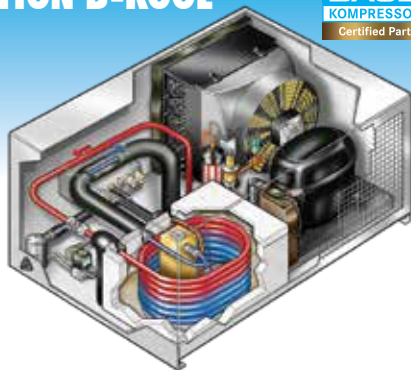

## DIN VALVE FOR AIR BANK



Din Valve 300bar for Air Bank...MAB900

## AIR STORAGE CYLINDERS



- MAB1
- Air Storage Cylinders
- 50 Liter Pressure Vessel with valve
- 300bar working pressure
- Steel cylinders with 10 year Hydro test
- Can be connected to custom specifications

Dive Supply's work shop facilities can clean, hydrostatically test & certify cylinders of all sizes

## BAUER PureAir Certification

"PureAir - Safe Diving": High quality breathing air is the most important element of your diving equipment. Insufficiently or even non-filtered air from the compressor may jeopardize the health & even the life of any sports diver. The BAUER PureAir Campaign offers any diver an easy to use guide for selecting trustworthy filling stations. By choosing to use BAUER state-of-the-art technology diving centers are able to meet the highest standards of Air Quality & are recognized with the award of the BAUER Pure Air Seal.

The exclusive BAUER PureAir Seal guarantees any diver that he or she really receives only the purest breathing air. Learn more at [www.bauerpureair.com/diving](http://www.bauerpureair.com/diving)



To find out how to get your BAUER PureAir Certification please contact our Sales & Service team.

## JUNIOR II

The most compact & highly mobile model in our diving compressor range. Due to its toughness & reliability the JUNIOR has become a global classic. JUNIOR II offers an even more compact design & numerous improvements in details. The patented TRIPLEX filter system guarantees purest breathing air according to DIN EN 12021.

\*Now available with optional automatic condensate drain & final pressure switch off.\*



## MARINER 200

With 200 l/min. It is the most versatile among the new units of the PROFILINE II. Crash frame in series.



## MARINER 250

Even more performance & equipped with the TRIPLEX P31 / P41 filter in series.



## MARINER 320

With 320 l/min. the new Mariner 320 is the most powerful portable compressor worldwide!



## TECHNICAL DATA

Type max. 330bar / 5000 psig	Drive	FAD L/min*	RPM min	Drive		Filter System TRIPLEX	Dimensions (app.cm)			Weight net (app.kg)
				kW	HP		L	W	H	
JUNIOR II - B	4-stroke petrol	100	2300	4.0	5.5	P21	78	34	42	44
JUNIOR II - W	Single phase	100	2300	2.2	3.0	P21	66	39	42	46
MARINER 200 - B	4-stroke petrol	200	1300	6.1	8.0	P21	125	59	63	115
MARINER 200 - E	3-phase	200	1300	4.0	5.5	P21	125	59	63	115
MARINER 250 - B	4-stroke petrol	250	1450	6.6	9.0	P31/P41	125	59	63	120
MARINER 250 - E	3-phase	250	1450	5.5	7.5	P31/P41	125	59	63	135
MARINER 320 - B	4-stroke petrol	320	1450	9.6	13	P31/P41	130	64.5	70	138
MARINER 320 - E	3-phase	320	1450	7.5	10	P31/P41	130	64.5	70	154

# MINI-VERTICUS

Now significantly quieter, thanks to the new anti-vibration frame & noise-optimised Super Silent housing;  
 Available with a higher charging rate of 320 l/min & with an open design as standard.  
 Fully automatic B-CONTROL MICRO compressor control with colour display  
 B-DRAIN: New automatic condensate drain is quieter & saves energy  
 Ergonomic design: optimum accessibility & operation  
 Long unit service life: use of high-quality materials that have been optimised for continuous use  
 Optional - Super Silent version, P61 Purification system, B-APP



- 225 & 330 Bar
- 150-320 l/min

Type Designation	Charging rate <sup>1</sup>		Max. operating Pressure (bar)	Speed (rpm)	Motor Output (kW)	Purification System	Weight net (kg)	Dimensions L x W x H (cm)
	l/min	m <sup>3</sup> /h						
MV 150	150	9	350	1340	4	P41	324	120x79x138
MV 200	200	12	350	1270	4	P41	324	120x79x138
MV 250	250	15	350	1470	5.5	P41	333	120x79x138
MV 320	320	19.2	350	1450	7.5	P41	350	120x79x138

Also available with switchover device 330 /225bar (5000/3300 psi)



# VERTICUS

For use in professional applications: High charging rate in continuous operation  
 Now significantly quieter: thanks to the new anti-vibration frame & noise-optimised Super Silent housing  
 B-DRAIN: New automatic condensate drain is quieter & saves energy  
 Fully automatic compressor control: B-CONTROL MICRO with colour display  
 Optional oil level monitoring system: For safely switching off the compressor unit when the oil level is low.  
 The VERTICUS series has been developed & built specifically to meet high performance requirements in continuous operation in professional applications.



- 225 & 330 Bar
- 450 – 680 l/min

Type Designation	Charging rate <sup>1</sup>			No. of Compr. Stages	Speed (rpm)	Motor Output (kW)	Purification System	Weight net (kg)	Dimensions L x W x H (cm)
	l/min	m <sup>3</sup> /h	cfm						
V 450	450	25.2	15.9	4	1320	11	P61	402	120x79x153
V 540	540	32.4	19.1	4	1230	11	P61	402	120x79x153
V 680	680	40.8	24.0	4	1400	15	P61	416	120x79x153



The **POSEIDON EDITION** represents an excellent value-for-money range of compressors without compromising typical **BAUER** quality. This product range has been developed for uncomplicated operation, combining proven core components from **BAUER** with a simple but robust chassis.



- 300 - 850 l/min
- 225 / 330 / 420bar

The new generation VE range excels through its high delivery rates of up to 850 l/min. Tailored for breathing protection & scuba diving requirements, the new compressor control offers quick & easy access to all important functions.



- 250 - 300 l/min
- 225 / 330bar

The PE-MVE is BAUER's compact all-in-one solution, offering high quality at outstanding value for money. Standard with Super Silent housing, automatic condensate drain system & the user friendly BHW-CONTROL control unit.



- 200 - 300 l/min
- 225 / 330bar

The PE 200 - 300-TE models offer the optimum weight / price ratio. Owing to their compact construction, the units are easy to transport & to load onto vehicles.



- 200 - 300 l/min
- 225 / 330bar

The PE 200 - 300-HE horizontal models are by far the most compact high pressure breathing air compressors in their class. The standard version comes already equipped with automatic condensate drain & easy-to-use control. Ideal for use on dive boats



- 100 l/min
- 225 / 330bar

The PE 100 is the smallest & lightest compressor unit of the PE range. With its three drive variants (petrol, three-phase & single-phase alternating current).



## SIMILAN ISLANDS

including KOH BON, KOH TACHAI, RICHELIEU ROCK (2nd Edition)

This convenient reference book is a must-have if you're planning a visit to the Similan Islands & surrounding areas. There are also lots of colourful dive site diagrams, descriptions of area dive characteristics & an abundance of practical information you'll need to know before you go.

- Information on the area, from topography to getting ready to dive there
- Detailed explanation of every dive site
- 20 full-colour illustrated underwater maps

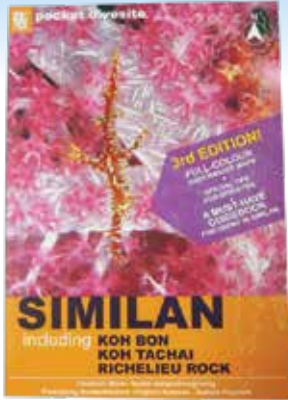

English...MPD01

## INDIAN OCEAN REEF GUIDE

by Helmut Debelius

Maldives - Sri Lanka - Thailand  
South Africa - Mauritius  
Madagascar - East Africa - Seychelles

The author made his first dives in tropical waters around Sri Lanka 25 years ago. Since then he explored virtually the entire Indian Ocean with his camera, diving not only in the tourist centers like the Maldives or Seychelles, but also taking UW-Photos at remote islands like Cocos-Keeling in the East or Aldabra in the West. The results are shown in this book including more than 1,000 photos from the natural habitat of the marine animals. Special emphasis was given to rare species like sharks & rays.

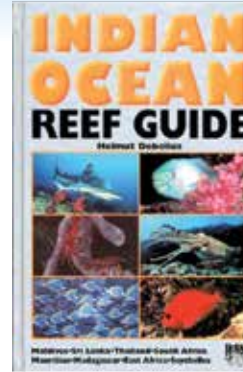

English... K1105

## INDIAN OCEAN MARINE GUIDE

Marine Pictolife describes more than 250 marine species.

- Totally waterproof
- Multilingual (5 languages as well as in Latin)
- Almost 250 species packed into 64 pages
- Paper captions in all 5 languages
- 2 indexes including 5 phyla (mobile & stationary species)
- Format: 12.5 X 16.3 cm
- Weight: 177 g



Multi Lingual...KP107



## TROPIC PACIFIC MARINE GUIDE

Marine Pictolife describes more than 250 marine species.

- Totally waterproof
- Multilingual (5 languages as well as in Latin)
- Almost 280 species packed into 64 pages
- Paper captions in all 5 languages
- 2 indexes including 5 phyla (mobile & stationary species)
- Format: 12.5 X 16.3 cm
- Weight: 177 g



Multi Lingual...KP109



## ASIA PACIFIC MARINE GUIDE

Marine Pictolife describes more than 250 marine species.

- Totally waterproof
- Multilingual (5 languages as well as in Thai)
- Almost 280 species packed into 64 pages
- Paper captions in all 5 languages
- 2 indexes including 5 phyla (mobile & stationary species)
- Format: 12.5 X 16.3 cm
- Weight: 177 g



Multi Lingual...KP113





SHORTY 3MM WETSUIT  
DBADS01

SHORTY 3MM WETSUIT  
DBADS02

SHORTY 3MM WETSUIT  
DBADS04

STEAMER 3MM WETSUIT  
DBADS03



GEAR BAG - 65 Liter  
DB8010



# WE CAN PRINT YOUR COMPANY LOGO ON THESE ITEMS:



GEAR BAG - 90 Liter  
DB8020



MASK STRAP  
DB6688

MASK STRAP  
COVER DB6689



LOG BINDERS  
DB8005

WATERPROOF POUCH  
DB8044



ADVENTURE DRY PACK  
DBBV05-DBBV15







Free Standing Display (Mesh)  
White 100 x 200 cm

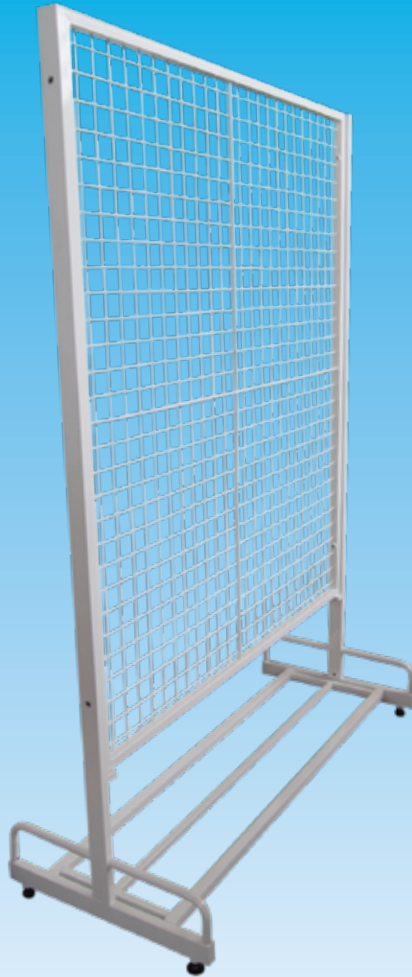

Free Standing Display (Mesh)  
White 100 x 150 cm

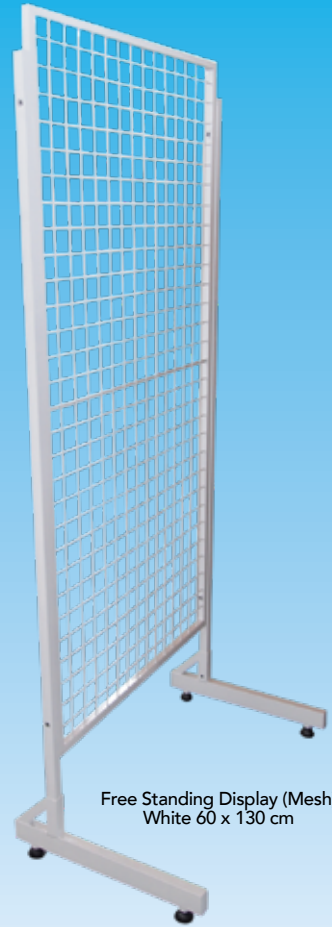

Free Standing Display (Mesh)  
White 60 x 130 cm

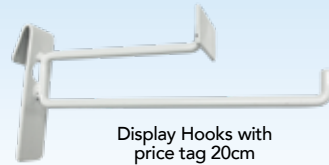

Display Hooks with  
price tag 20cm

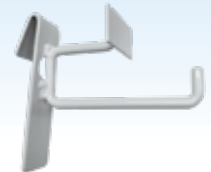

Display Hooks with  
price tag 10cm

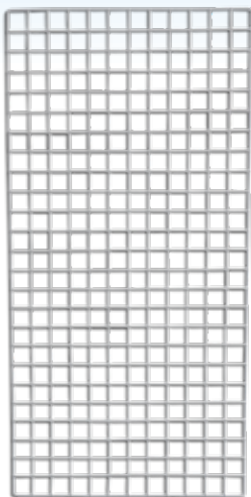

Mesh Display (PVC Coated)  
White 50cm x 100cm



Mesh Shelf PVC coated  
White 17cm x 100cm



Acrylic A4 Flyer Display  
Stand (Portrait format)

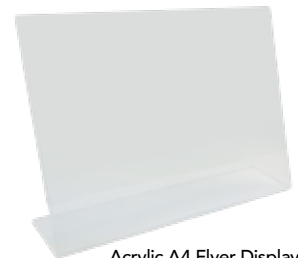

Acrylic A4 Flyer Display  
Stand (Landscape format)

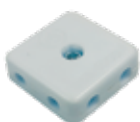

Mesh Joiner



Mask Stand - Free  
Standing (Clear)



Acrylic A4 Flyer Display  
Stand (Portrait format)



Acrylic Hook Display Shelf  
for Grid/Mesh frame  
(W 19cm x D 11.5cm x H 6.5cm)  
or  
(W 19cm x D 7.5cm x H 8.5cm)



## WALL RAILS CHROMIUM

Available in: 60, 90, 120, 150, 180cm

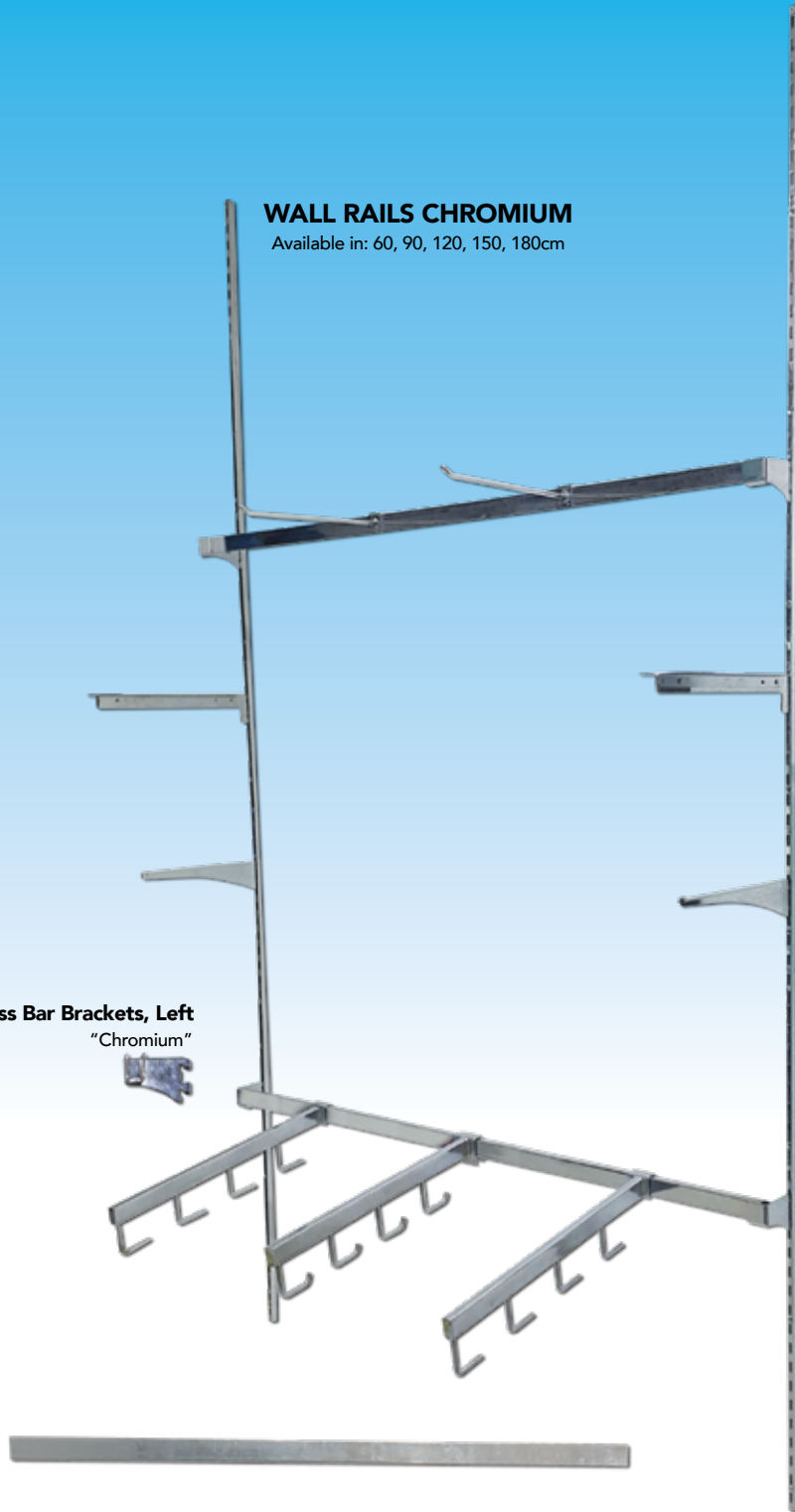

**Cross Bar Brackets, Left**  
"Chromium"



**Accessory Hooks 25cm**  
"Chromium"



**Wood Shelf Brackets 30cm**  
"Chromium"



**Glass Shelf Brackets 25cm**  
"Chromium"



**Cross Bar Brackets, Right**  
"Chromium"



**Fin Hooks 4 hooks**  
"Chromium"

**Cross Bars 90cm**  
"Chromium"







## **DIVE SUPPLY HISTORY**

### **Diving & Snorkeling Equipment Wholesale Specialist**

Dive Supply is the leading distributor and wholesaler of major brand name scuba diving and water sports equipment in South East Asia and is the exclusive distributor for Scubapro, Suunto, Deep Blue Products, Seac, Pelican, Saekodive, Bauer, Luxfer, Tovatec, Olympus, Divevolk and Maxtec.

We operate from our 1,500 sqm custom built warehouse in Chalong, Phuket, where we have a fully equipped service center.

If you are looking for the leading brands in Diving and Snorkeling Equipment along with value for money and excellent customer service then Dive Supply is the place to come.

We have a product portfolio which is second to none and we are the main distributor for PADI materials throughout Thailand.



[sales@divesupply.com](mailto:sales@divesupply.com)  
[www.divesupply.com](http://www.divesupply.com)  
[facebook/DiveSupply](https://facebook.com/DiveSupply)



Dive Supply Co., Ltd.  
88/5 Moo10 Patak Road,  
Chalong,Phuket,Thailand



Tel : +66 (0) 76 383 414-6  
Fax : +66 (0) 76 281 525







Model: Jamie Piyada  
IG: jamiemisscuba

Photo: Todd Thimios  
IG: toddthimios

## **Dive Supply Main Office (Phuket)**

88/5 Moo10 Patak Road, Chalong, Muang, Phuket, 83130 Thailand

**Tel :** +66 (0) 76 383 414-6 , **Fax :** +66 (0) 76 281 525

**Email :** sales@divesupply.com , **Website :** www.divesupply.com

**Facebook :** www.facebook.com/DiveSupply

**Bangkok Dive Supply**  
contact@divesupplybkk.com  
**Tel :** +66 (0) 2 354 4815  
**Fax :** +66 (0) 2 354 4819

**Koh Tao Dive Supply**  
info@kohtaodivesupply.com  
**Tel :** +66 (0) 77 456 162

**Samui Dive Supply**  
info@samuidivesupply.com  
**Tel :** +66 (0) 77 230 063  
**Fax :** +66 (0) 77 230 186

**Koh Chang Dive Supply**  
info@kohchangdivesupply.com  
**Tel :** +66 (0) 39 551 518  
**Fax :** +66 (0) 39 551 519